

J.P. VOS

HI THERM PRODUCTS



S.P.R.L.

MODINOX
CONDUITS DE CHEMINÉE

TARIF HTVA

EXCL. BTW TARIEF

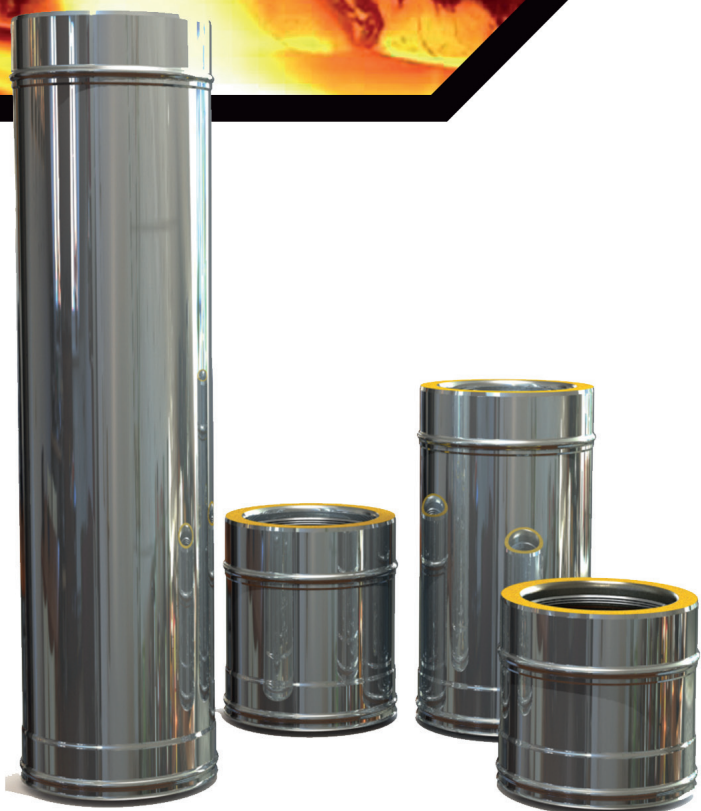

LONG UTILE NUTTIGE LENGTE	LONG TOTAL TOTALE LENGTE	INOX			LAQUÉ NOIR ZWART GELAKT			
		ØINT/BIN	80	100	ØINT/BIN	80	100	
		ØEXT/BUIT	140	160	ØEXT/BUIT	140	160	
TUBE AVEC COLLIER - BUIS MET BEUGEL								
1400 MM	1330 MM	REF	IDMI801400	IDMI1001400		REF	IDMN801400	IDMN1001400
		€	113,41	125,50		€	123,50	134,22
1000 MM	930 MM	REF	IDMI801000	IDMI1001000		REF	IDMN801000	IDMN1001000
		€	87,29	94,27		€	94,27	103,26
500 MM	430 MM	REF	IDMI80500	IDMI100500		REF	IDMN80500	IDMN100500
		€	61,52	70,13		€	66,87	76,23
250 MM	180 MM	REF	IDMI80250	IDMI100250	REF	IDMN80250	IDMN100250	
		€	50,34	58,87	€	54,72	63,99	
RÉGLABLE 365 - 565 MM REGELBAAR	RÉGLABLE 300 - 500 MM REGELBAAR	REF	IDMIAJ80	IDMIAJ100	REF	IDMNAJ80	IDMNAJ100	
		€	74,16	80,73	€	80,61	87,75	

COUDE AVEC COLLIER - BOCHT MET BEUGEL							
30°	REF	IDMIC30/80	IDMIC30/100		REF	IDMNC30/80	IDMNC30/100
	€	78,08	85,48		€	84,47	92,91
45°	REF	IDMIC45/80	IDMIC45/100		REF	IDMNC45/80	IDMNC45/100
	€	78,08	85,48		€	84,47	92,91

TÉ AVEC TAMPON - T-STUK MET DOP							
90°	REF	IDMITB80	IDMITB100		REF	IDMNTB80	IDMNTB100
	€	119,01	129,89		€	129,36	141,18
135°	REF	IDMITYB80	IDMITYB100		REF	IDMNTYB80	IDMNTYB100
	€	207,94	227,34		€	226,02	247,11
90° RÉDUIT PIQUAGE SP 90° VERKLEIND MOF EW	REF	IDMI T80PSP80X	IDMI T100PSP100X		REF	IDMN T80PSP80X	IDMN T100PSP100X
	€	103,47	112,92		€	118,99	129,86
	REF	-	IDMI T100PSP80X	REF	-	IDMN T100PSP80X	
	€	-	112,92	€	-	129,86	
X = M/F À PRÉCISER - M/VR TE BEVESTIGEN				X = M/F À PRÉCISER - M/VR TE BEVESTIGEN			

ELEMENT DE RAMONAGE - BUIS MET KUISDEUR							
REF	IDMITR80	IDMITR100		REF	IDMNR80	IDMNR100	
€	68,48	76,52		€	82,17	91,83	

PURGE - CONDENSATIEAFVOER							
REF	IDMIP80	IDMIP100		REF	IDMNP80	IDMNP100	
€	37,81	44,52		€	41,10	48,39	

COLLIER DE JONCTION - KLEMBAND							
REF	IDMIBS80	IDMIBS100		REF	IDMNB80	IDMNB100	
€	13,25	13,25		€	14,40	14,40	

JOINT D'ÉTANCHÉITÉ FIBRE • FIBERRING			
REF	IDMJF80	IDMJF100	
€	5,52	6,45	

ACCESSOIRES - INOX - TOEBEHOREN		
ØINT/BIN	80	100
ØEXT/BUIT	140	160

ACCESSOIRES LAQUÉ NOIR ZWART GELAKT TOEBEHOREN		
ØINT/BIN	80	100
ØEXT/BUIT	140	160

COLLIER MURAL 20 - 120 MM - MUURBEUGEL 20 - 120 MM

REF	IDMIBMR80	IDMIBMR100
€	25,92	26,64

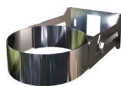

REF	IDMNBMR80	IDMNBMR100
€	29,81	30,64

RALLONGE MURAL 55 - 600 MM - VERLENGSTUK 55 - 600 MM

REF	IDMIRBM300	IDMIRBM600
€	70,00	82,63



REF	IDMNRBM300	IDMNRBM600
€	79,88	95,09

SUPPORT MURAL - MUURSTEUN

REF	IDMISMI80	IDMISMI100
€	85,73	87,46

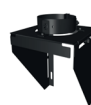
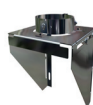

REF	IDMNSMI80	IDMNSMI100
€	93,18	95,07

SUPPORT AU SOL RÉGLABLE - VLOERSTEUN REGELBARE

REF	IDMISSR80100
€	45,05



REF	IDMNSSR80100
€	49,58

COLLIER MULTIFONCTION - SPANKABELBEUGEL

REF	IDMIBH80	IDMIBH100
€	16,38	16,38



REF	IDMNBH80	IDMNBH100
€	20,76	20,76

PLAQUE DÉPART SOL - BODEM PLAAT

REF	IDMIPDS80	IDMIPDS100
€	98,81	106,70

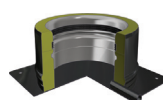
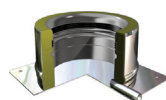

REF	IDMNPDS80	IDMNPDS100
€	107,04	115,20

PLAQUE DE BASE ANCRAGE BOISSEAU - SCHOUWOPHOOGING

REF	IDMIPB80	IDMIPB100
€	65,49	76,57

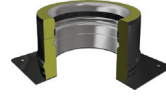
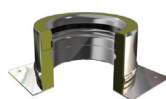

REF	IDMNPB80	IDMNPB100
€	75,31	88,07

PLAQUE DE BASE ANCRAGE BOISSEAU SP - SCHOUWOPHOOGING MET EW MOF

REF	IDMIPD80	IDMIPD100
€	76,09	82,17

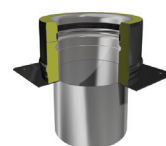
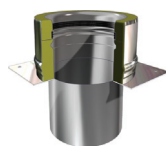

REF	IDMNPD80	IDMNPD100
€	82,17	89,31

ACCESSOIRES - GALVA - TOEBEHOREN

ØINT/BIN	80	100
ØEXT/BUIT	140	160

COLLIER SOUS TOITURE • DAKSTEUN

REF	IDMIST80	IDMIST100
€	32,77	32,77



01 : Ø INT <230MM

03 : Ø INT >230MM



	01	03
RÉHAUSSE COLLIER CHARPENTE BOIS VERBETERINGSONDERSTEUNINGSKETING HOUT FRAME		
REF	IDMIRCS01	IDMIRCS03
€	19,13	38,54

SUPPORT PLANCHER • VERDIEPONDERSTEUNING

REF	IDMISPR80	IDMISPR100
€	50,77	59,92

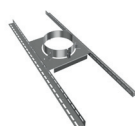

02 : Ø INT <230MM

04 : Ø INT >230MM



	02	04
RÉHAUSSE COLLIER CHARPENTE BÉTON VERBETERINGSONDERSTEUNINGSKETING BETON FRAME		
REF	IDMIRCS02	IDMIRCS04
€	19,13	38,54

*laqué blanc sur commande
*wit gelakt op bestelling

FINITIONS - INOX - AFWERKING		
ØINT/BIN	80	100
ØEXT/BUIT	140	160

LAQUÉ NOIR - ZWART GELAKT		
ØINT/BIN	80	100
ØEXT/BUIT	140	160

ÉLÉMENT DÉPART PLAFOND - LONGEUR 450 MM AVEC COLLIER - DW BUIS VOOR PLAFOND AANSLUITING 450MM MET KLEMBAND

STANDARD	REF	IDMIRP80	IDMIRP100
	€	185,11	185,11
RÉDUIT VERBLEIND	REF	-	IDMIRP10080
	€	-	185,11



REF	IDMNRP80	IDMNRP100
€	201,21	201,21
REF	-	IDMNRP10080
€	-	201,21

ROSACE POUR EDP - SCHOUWPLAAT VOOR EDP

BORD TOMBÉ AFGERONDE BOORD	REF	IDMIRBT80	IDMIRBT100
	€	21,07	21,07
PLATE 4 TROUS FLATE 4 GATEN	REF	IDMIR80	IDMIR100
	€	20,07	20,07



REF	IDMNRBT80	IDMNRBT100
€	23,02	23,02
REF	IDMNR80	IDMNR100
€	21.81	21.81

FIXATIONS - BEVESTIGING

KIT DE FIXATION MAGNÉTIQUE - KIT MAGNETISCHE BEVESTIGING

REF	IDMKITAIM
€	21,34



COLLIER AIMANT - MAGNEET BEUGEL

REF	IDMCOA180	IDMCOA100
€	25,44	



SOLUTIONS DE DÉPASSEMENT - OVERLOOP OPLOSSINGEN

HAUTEUR DE DÉPASSEMENT OVERLOOP HOOGTE	SOLUTIONS - OPLOSSINGEN
JUSQU'À - TOT 1,50 M	UTILISATION DU COLLIER GEBRUIK VAN KLEMBAND
DE 1,50 À 3 M VOOR 1.50 TOT 3 M	HAUBANNAGE CLASSIQUE GEWOON TUIDDRAAD
	KIT DE NON-HAUBANNAGE EXTRA BREED KLEMBAND
AU DELÀ DE - BOVEN 3 M	HAUBANNAGE SELON DTU OU FABRICANT TUIDDRAAD VOLGENS DTU OF FABRIKANT

APERCU - OVERZICHT

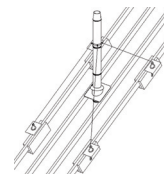

COLLIER DE DÉPASSEMENT - OVERLOOP KLEMBAND

REF	IDMIBSL80	IDMIBSL100
€	12,34	12,34



REF	IDMNBSL80	IDMNBSL100
€	13,58	13,58

KIT DE NON HAUBANAGE - EXTRA BREED KLEMBAND

REF	IDMIBSEL80	IDMIBSEL100
€	38,60	42,45



REF	IDMNBSEL80	IDMNBSEL100
€	42,45	46,70

ACCESSOIRES - INOX - TOEBEHOREN			
ØINT/BIN	80	100	
ØEXT/BUIT	140	160	

ACCESSOIRES LAQUÉ NOIR ZWART GELAKT TOEBEHOREN			
ØINT/BIN	80	100	
ØEXT/BUIT	140	160	

RACCORD SIMPLE STANDARD SP/DP - OVERGANGSTUK EW/DW

MALE - MAN	REF	IDMIASD80	IDMIASD100
	€	36,90	40,93
FEMELLE - VROUW	REF	IDMIASD80F	IDMIASD100F
	€	36,90	40,93



REF	IDMNASD80	IDMNASD100
	€	40,11
REF	IDMNASD80F	IDMNASD100F
	€	40,11

RACCORD SIMPLE RÉDUIT SP/DP 100 > 80 - OVERGANGSTUK EW/DW 100 > 80

MALE - MAN	REF	-	IDMIASD100/80
	€	-	49,10
FEMELLE - VROUW	REF	-	IDMIASD100/80F
	€	-	49,10



REF	-	IDMNASD100/80
	€	-
REF	-	IDMNASD100/80F
	€	-

RACCORD SIMPLE INVERSÉ DP/SP - ONVERGANGSTUK DW/EW

REF	IDMIADS80	IDMIADS100
€	44,27	49,10



REF	IDMNADS80	IDMNADS100
€	48,12	53,37

RECouvreMENT PLAQUE DISTANCE SÉCURITÉ - AFDEKPLATEN VOOR IDMEDS - IDMPPE

REF	IDMIRPC80	IDMIRPC100
€	43,44	43,44



REF	IDMNRPC80	IDMNRPC100
€	47,22	47,22

CHAPEAU - KAP

REF	IDMICH80	IDMICH100
€	47,94	52,27



REF	IDMNCH80	IDMNCH100
€	52,11	56,82

CHAPEAU ANTI-REFOULEUR - ANTI-WIND KAP

REF	IDMICA80	IDMICA100
€	84,04	91,58

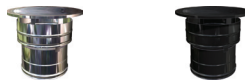

REF	IDMNCA80	IDMNCA100
€	91,35	99,54

MITRON - CONISCH EINDSTUK

REF	IDMIFH80	IDMIFH100
€	67,98	71,31



REF	IDMNFH80	IDMNFH100
€	73,89	77,52

	80	100
CACHE RACCORD COULISSANT GRAND CARRÉ SCHUIFKANAALAFDEKING GROOT VIERKANT		
REF	IDMNCCC80	IDMNCCC100
€	135,95	135,96

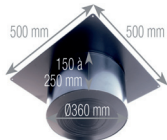

	80	100
CACHE RACCORD COULISSANT GRAND ROND SCHUIFKANAALAFDEKING GROOT ROND		
REF	IDMNCCGR80	IDMNCCGR100
€	135,96	135,96

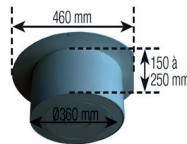

	80	100
CACHE RACCORD COULISSANT PETIT ROND SCHUIFKANAALAFDEKING KLEINE ROND		
REF	IDMNCCPR80	IDMNCCPR100
€	114,87	114,87

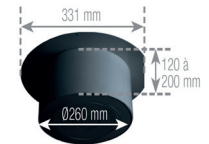

	80	100
ÉLÉMENT PLAQUE DISTANCE SÉCURITÉ BRANDSEPARATIE ELEMENT		
REF	IDMEDS80	IDMEDS100
€	35,88	36,79



	80	100
PLAQUE COUPE FEU ANTI-BRANDPLAAT		
REF	IDMCF80	IDMCF100
€	19,29	19,29

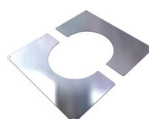

	80	100
PLAQUE VENTILÉ POUR PLAFOND VENTILATIE-PLAAT		
REF	IDMPV80	IDMPV100
€	17,34	18,49

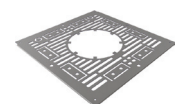

SOLIN - INOX - DAKDOORVOER		
ØINT/BIN	80	100
ØEXT/BUIT	140	160

SOLIN INOX LAQUÉ NOIR ZWART GELAKT INOX DAKDOORVOER		
ØINT/BIN	80	100
ØEXT/BUIT	140	160

SOLINS - INOX - DAKDOORVOER							
PLAT	REF	IDMISOLI80-0	IDMISOLI100-0		REF	IDMNSOLI80-0	IDMNSOLI100-0
	€	78,36	78,36		€	90,12	90,12
5° - 30°	REF	IDMISOLI80-5	IDMISOLI100-5		REF	IDMNSOLI80-5	IDMNSOLI100-5
	€	100,18	100,18		€	128,48	128,48
31° - 45°	REF	IDMISOLI80-30	IDMISOLI100-30		REF	IDMNSOLI80-30	IDMNSOLI100-30
	€	106,35	106,35		€	122,30	122,30
RACCORD TUILE VERBINDING OP DAKPANNEN	REF	IDMRTSOLI	IDMRTSOLI		REF	IDMNSOLI80-30	IDMNSOLI100-30
	€	78,36	78,36		€	122,30	122,30

SOLINS PLOMB DAKDOORVOER LOODSLAB	
--------------------------------------	--

SOLIN PLOMB + CONE LAQUÉ NOIR SANS LARMIER	
---	--

SOLINS PLOMB - DAKDOORVOER LOODSLAB							
5° - 30°	REF	IDMISOLP80-5	IDMISOLP100-5		REF	IDMNSOLP80-5	IDMNSOLP100-5
	€	98,00	102,50		€	119,00	126,00
31° - 45°	REF	IDMISOLP80-30	IDMISOLP100-30		REF	IDMNSOLP80-30	IDMNSOLP100-30
	€	104,00	110,37		€	126,00	135,00

80	100
----	-----

80	100
----	-----

LARMIER - STORMKRAAG							
	REF	IDMILA80	IDMILA100		REF	IDMNLA80	IDMNLA100
	€	18,00	19,62		€	19,56	21,33

80	100
----	-----

JOINT EPDM POUR LARMIER - EPDM RING VOOR STORMKRAAG		
REF	IDMIJLA80	IDMIJLA100
€	7,78	7,78



KIT ISOLATION ISOLATIE KIT		
ØINT/BIN	80	100
ØEXT/BUIT	140	160
KIT FOURP		

ISOLATION TRAVERSÉE DE PLAFOND - PLAFOND DOORVOER ISOLATIE			
KIT COMPLET PLANCHER BOIS [COLLIER + RÉHAUSSE] KIT HOUT VLOER	REF	IDMKITRPBO80	IDMKITRPBO100
	€	122,40	122,40
KIT COMPLET PLANCHER BÉTON [COLLIER + RÉHAUSSE] KIT BETON VLOER	REF	IDMKITRPBE80	IDMKITRPBE100
	€	140,09	140,09
PLAQUE ÉTANCHE DROITE + JOINT SILICONE PLAFOND PLAAT MET SILICONE DICHTINGSRING	REF	IDMPEPL80	IDMPEPL100
	€	55,83	55,83
FOURREAU ISOLANT [500MM] AVEC CEINTURE ISOLERENDE SCHEDE MET RIEM	REF	IDMFOPPL80	IDMFOPPL100
	€	59,76	59,76
PLAQUE DE PROPRETÉ DROITE LAQUÉ BLANCHE AVEC JOINT SILICONE WIT AFWERKINGSPLAAT MET SILICONE DICHTINGSRING <small>*SUR COMMANDE - OP BESTELLING</small>	REF	IDMBPP80/0	IDMBPP100/0
	€	37,25	37,25
PLAQUE DE DISTANCE DE SÉCURITÉ NON VENTILÉE BRANDSEPARATIE ELEMENT	REF	IDMPE80	IDMIPE100
	€	29,52	29,52

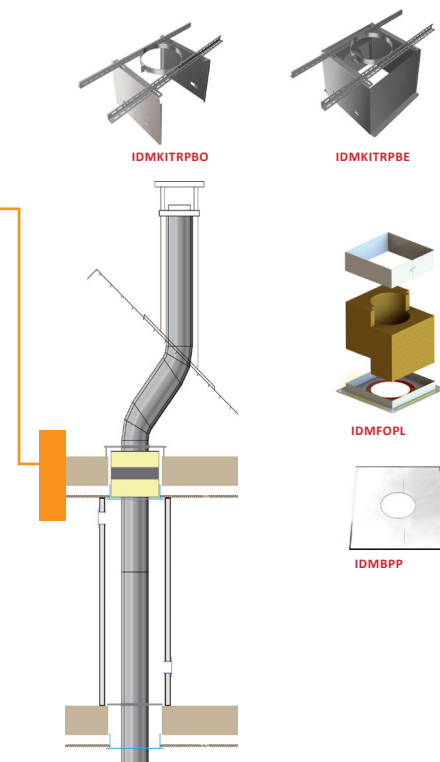

KIT ISORA				
ISOLATION TRAVERSÉE DE PLAFOND EN RAMPANT - ISOLATIE VOOR DAK-HELLING				
P : 16 = 16° - 23°	P : 24 = 24° - 31°	P : 32 = 32° - 38°	P : 39 = 39° - 45°	
KIT COMPLET COMPLETE KIT	REF	IDMKITRA80/P	IDMKITRA100/P	
	€	209,53	209,53	
FOURREAU ISOLANT AVEC CEINTURE ISOLERENDE SCHEDE MET RIEM	REF	IDMFORA80/P	IDMFORA100/P	
	€	124,55	124,55	
PLAQUE ÉTANCHE + JOINT SILICONE PLAFOND PLAAT MET SILICONE DICHTINGSRING	REF	IDMPERA80/P	IDMPERA100/P	
	€	60,21	60,21	
PLAQUE DE PROPRETÉ SOUS RAMPANT INOX AFWERKINGSPLAAT VOOR DAK-HELLING	REF	IDMIPP80/P	IDMIPP100/P	
	€	32,43	32,43	
PLAQUE DE PROPRETÉ SOUS RAMPANT LAQUÉ NOIRE ZWART AFWERKINGSPLAAT VOOR DAK-HELLING	REF	IDMNPP80/P	IDMNPP100/P	
	€	35,25	35,25	
PLAQUE DE PROPRETÉ SOUS RAMPANT LAQUÉ BLANCHE WIT AFWERKINGSPLAAT VOOR DAK-HELLING <small>*SUR COMMANDE - OP BESTELLING</small>	REF	IDMBPP80/P	IDMBPP100/P	
	€	37,25	37,25	

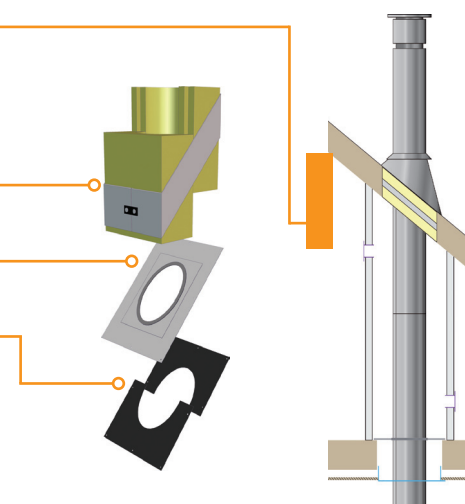

KIT ISOMU			
ISOLATION TRAVERSÉE MURALE - MUUR ISOLATIE			
KIT COMPLET [INCLUT PLAQUE DE PROPRETÉ BLANCHE] COMPLETE KIT [WIT AFWERKINGSPLAAT INBEGREPEN]	REF	IDMKITMU80	IDMKITMU100
	€	261,78	269,64
FOURREAU ISOLANT AVEC CEINTURE ISOLERENDE MET RIEM	REF	IDMFOMU80	IDMFOMU100
	€	78,21	78,21
PLAQUE ÉTANCHE DROITE + JOINT SILICONE PLAFOND PLAAT MET SILICONE DICHTINGSRING	REF	IDMPEMU80	IDMPEMU100
	€	55,83	55,83
PLAQUE DE PROPRETÉ DROITE EN INOX RECHTE AFWERKINGSPLAAT	REF	IDMIPP80/0	IDMIPP100/0
	€	32,43	32,43
PLAQUE DE PROPRETÉ DROITE LAQUÉ NOIRE ZWART RECHTE AFWERKINGSPLAAT	REF	IDMNPP80/0	IDMNPP100/0
	€	35,25	35,25
PLAQUE DE PROPRETÉ DROITE LAQUÉ BLANCHE WIT RECHTE AFWERKINGSPLAAT <small>*SUR COMMANDE - OP BESTELLING</small>	REF	IDMBPP80/0	IDMBPP100/0
	€	37,25	37,25

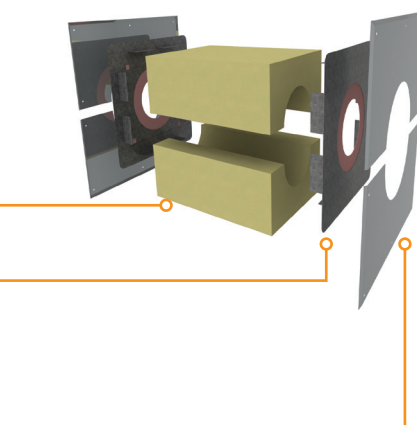

• **CONDUIT VERTICAL EXTÉRIEUR : PLA ASSOCIÉ À UN CONDUIT PTR.**
 • **VERTICALE ROOKKANAAL : PLA(CONCENTRISCHE) MET PTR GEISOLEERDE ROOKKANAAL**



• Application principale - hoofdtoepassing :

- Poêles
- Inserts
- Chaudières à pellets
- Kachels
- Inbouw haarden
- Pellets kachels

• Installation dans - plaatsing :

- Batiments individuels | - Prive woningen

• Combustible - brandstof :

- Pellets

Composition configuration - samenstelling :

- | | |
|---|--|
| 1. Mitron | 1. Afwerkingscone |
| 2. Collier multifonction | 2. Tuidraadbeugel |
| 3. Hauban | 3. Spankabel |
| 4. Collier mural | 4. Muurbeugel |
| 5. Element droit | 5. Rechte buis |
| 6. Support mural | 6. Muursteun |
| 7. Purge | 7. Condensafvoer |
| 8. Kit ISOMU | 8. ISOMU kit |
| 9. Kit adaptateur PLA horizontal sur PTR vertical extérieur | 9. Verbindingskit tussen PLA horizontaal en PTR verticaal buiten |

Application adaptateur PLA sur PTR :
 Samenstelling : PLA op PTR :

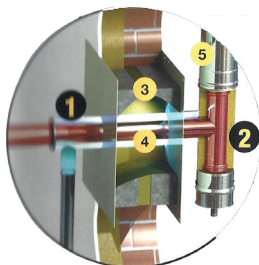

- | | |
|--------------------------------|------------------------------------|
| 1. Raccord Air PLA seul inox | 1. Overgangstuk inox PLA |
| 2. Té PTR pour raccord Air PLA | 2. T-stuk PTR met overgangstuk PLA |
| 3. Kit ISOMU | 3. ISOMU kit |
| 4. Élément droit PLA | 4. PLA buis (concentrische) |
| 5. Conduit extérieur PTR30 | 5. Buiten rookkanaal DW PTR30 |

Ø INTERIEUR - BINNEN	80	100
Ø EXTERIEUR - BUITEN	140	160
CARACTÉRISTIQUES TECHNIQUES - PTR 30 PELLET - TECHNISCHE KENMERKEN		
PAROI INTÉRIEURE - BINNEWAND	INOX 316L 4/10	
PAROI EXTÉRIEURE - BUITENWAND	INOX 304 4/10	
ISOLATION - ISOLATIE	LAINE DE ROCHE - ROOKWOOL 140KG/M ³ + BOUCHONS - DOP 140KG/M ³	
ÉPAISSEUR ISOLANT - ISOLATIE DIKTE	30 MM	
EMBOITEMENT - INEENSCHUIVING	70 MM	
COLLIER DE JONCTION - KLEMBAND	À GRENOUILLÈRE - CLIPS (fourni avec chaque élément - inbegrepen)	
JOINT - DICHTINGSRING	FIBRE- FIBER (fourni - geleverd)	FIBRE - FIBER (à commander - op bestelling)
RU	0,51 m ² K/W**	
CLASSIFICATION - CLASSIFICATIE	T450 N1 W VM L50040 G50 - T450 N1 WT VM L50040 G80 (selon DTU 24.1)	

PLA INOX		
ØINT/BIN	80	100
ØEXT/BUIT	140	160

LAQUÉ NOIR - PLA - ZWART GELAKT		
ØINT/BIN	80	100
ØEXT/BUIT	140	160

ADAPTATEUR PLA HORIZONTAL SUR PTR VERTICAL EN EXTÉRIEUR - VERBINDINGSBIT PLA CONCENTRISCHE VOOR PTR DW ROOKKANAAL

KIT COMPLET	REF	IDMIPLAPTR80F	IDMIPLAPTR100F
	€		169,97

REF	IDMNPLAPTR80F	IDMNPLAPTR100F
	€	195,46

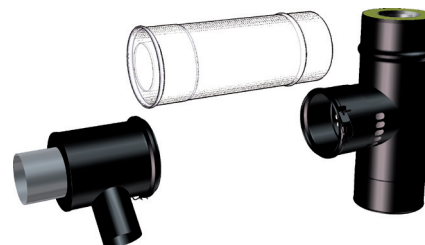

ØINT/BIN	80	100
ØEXT/BUIT	125	153

ØINT/BIN	80	100
ØEXT/BUIT	125	153

RACCORDS AIR ET TÉ PTR - MOF LUCHTTOEVOER EN T-STUK DW

RACCORD AIR PLA MÂLE PLA MOF LUCHT MANNEN	REF	IDMIRA8060	IDMIRA10060
	€	48,90	57,31
RACCORD AIR PLA FEMELLE PLA MOF LUCHT VROUWEN	REF	IDMIRA8060F	IDMIRA10060F
	€	48,90	57,31
TÉ PTR T-STUK DW	REF	IDMITCOAX80	IDMITCOAX100
	€	121,04	125,62
TÉ PTR RÉDUIT T-STUK DW VERKLEIND	REF	-	IDMITCOAX10080
	€	-	125,62
BUSE 500MM CONCENTRISCHE 500MM	REF	IDMICOAX80/50	IDMICOAX100/50
	€	46,61	51,05

REF	IDMNRA8060	IDMNRA10060
	€	56,23
REF	IDMNRA8060F	IDMNRA10060F
	€	56,23
REF	IDMNTCOAX80	IDMNTCOAX100
	€	139,80
REF	-	IDMNTCOAX10080
	€	-
REF	IDMNCOAX80/50	IDMNCOAX100/50
	€	53,60

CONCENTRIQUE PELLETS - CONCENTRISCHE VOOR PELLETS KACHELS

KIT RACCORDEMENT TERMINAL HORIZONTAL Ø80 NOIR - KIT GEVEL Ø80 ZWART

KIT	REF	IDMNKITPLA80
	€	564,14
QTÉ	CONTENU - INHOUD	
1	TERMINAL HORIZONTAL PLA 80/125 - HORIZONTAAL UITGANG CONCENTRISCHE PLA 80/125	
1	BUSE 500MM PLA 80/125 - BUIS CONCENTRISCHE 500MM PLA 80/125	
2	ROSACE DE FINITION SILICONE PLA Ø125 EXT - AFWERKING SCHOUWPLAAT SILICONE PLA Ø125 BUITEN	
1	COUDE 90° PLA 80/125 - BOCHT 90° PLA 80/125	
1	BUSE RÉGLABLE PLA 80/125 - REGELBARE BUIS PLA 80/125	
1	BUSE 1000MM PLA 80/125 - BUIS CONCENTRISCHE 1000MM PLA 80/125	
1	T 90° PIQUAGE AIR Ø60 PLA 80/125 - T-STUK LUCHTTOEVOER Ø60 PLA 80/125	
1	T 90° PIQUAGE FUMÉES FEM. PLA 80/125 - T-STUK ROOKAFVOER VROUWEN PLA 80/125	
1	MANCHON SOUPLE EPDM 60/40 - EPDM MOF 60/40	
0,5	FLEXIBLE Ø60 - FLEXIBEL Ø60	
1	MANCHON RECOUPABLE F/M 80 - SNIJBAAR MOF VR/M 80	

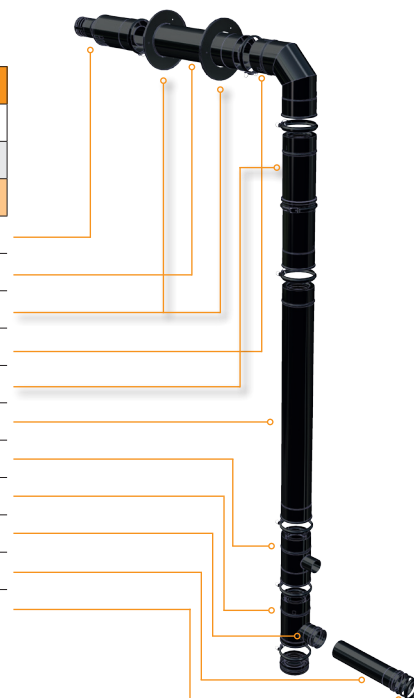

1856-2 T500 N1 W VM L01120 G (375) NM
 HAUTE TEMPÉRATURE 500°C SANS JOINT • HOOGTEMP. 500°C ZONDER DICHTINGSRING

	∅	80	100
TUBE - BUIS			
2000 MM	REF	AN-80*200	AN-100*200
	€	63,00	69,70
1000 MM	REF	AN-80*100	AN-100*100
	€	29,90	36,68
500 MM	REF	AN-80*050	AN-100*050
	€	21,40	29,99
250 MM	REF	AN-80*025	AN-100*025
	€	18,50	27,65

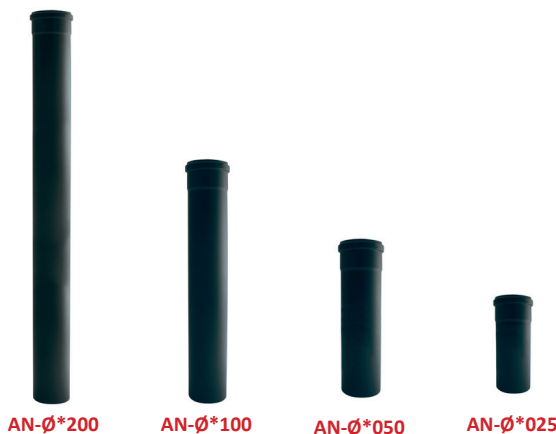

		80	100
TÉ - T-STUK			
T90° F + TAMPON T90° VR + DOP	REF	AN-T80F	AN-T100F
	€	45,44	61,75
T90° F PIQUAGE ∅80 + TAMPON T90° VR VERBINGING ∅80 + DOP	REF	-	AN-T100-80F
	€	-	65,00
T90° F FERMÉ BAS + 2 PORTES DE VISITE T90° VR GESLOTEN + 2 KUISDEUR	REF	AN-TI80F	AN-TI100F
	€	54,00	69,90



		80	100
COUDE - BOCHT			
COUDE 90° BOCHT 90°	REF	AN-C9080	AN-C90100
	€	36,84	46,63
COUDE 90° + PORTE DE VISITE BOCHT 90° + KUISDEUR	REF	AN-CI80	AN-CI100
	€	47,12	52,88
COUDE 45° BOCHT 45°	REF	AN-C4580	AN-C45100
	€	33,12	40,85



		80	100
ACCESSOIRES - TOEBEHOREN			
PASSAGE MURAL + JOINT MUURAANSLUITING + DICHTINGSRING	REF	AN-PM80	AN-PM100
	€	56,15	61,75
MANCHON MALE-MALE MOF MAN-MAN	REF	AN-MM80	AN-MM100
	€	22,57	22,57
MANCHON FEMELLE-FEMELLE MOF VEOUW-VROUW	REF	AN-MF80	AN-MF100
	€	17,86	22,33
ROSACE DE FINITION SCHOUWPLAAT	REF	AN-R80	AN-R100
	€	11,00	15,20
ROSACE DE FINITION ELLIPTIQUE OVAAL SCHOUWPLAAT	REF	AN-RE80	AN-RE100
	€	20,00	21,00
COLLIER MURAL MUURBEUGEL	REF	AN-CM80	AN-CM100
	€	13,56	14,73
COLLIER MURAL RÉGLABLE MAX.120MM REGLBARE MUURBEUGEL MAX.120MM	REF	E.NM-CMR80	E.NM-CMR100
	€	13,78	13,78
JOINT D'ÉTANCHÉITÉ SILICONE DICHTINGSRING T200°C	REF	AN-J80	AN-J100
	€	3,29	3,54
AUGMENTATION ∅100F - ∅80M REDUCTIE ∅100VR-∅80MAN	REF	-	AN-RD100-80
	€		30,98
RÉDUCTION 80F-100M REDUCTIE	REF	AN-RD80-100	-
	€	30,98	
ROSACE SILICONE NOIRE ZWART SILICON SCHOUWPLAAT	REF	RCN-80	RCN-100-
	€	VOIR - ZIE P11	



	∅	80	100
TUBE - BUIS			
1000 MM	REF	E.NM-80*100	E.NM-100*100
	€	34,88	36,47
500 MM	REF	E.NM-80*50	E.NM-100*50
	€	26,19	27,60
330 MM	REF	E.NM-80*33	E.NM-100*33
	€	23,30	24,95
330 MM + TRAPPE 330 MM + KUIDEUR	REF	E.NM-80*33TR	-
	€	38,61	-
160 MM	REF	ENM-80*16	-
	€	16,41	-
COULISSANT 500 MM REGBARE 500MM	REF	ENM-TEL80	ENM-TEL100
	€	27,60	32,38

TÉ - T-STUK			
T90° F PIQUAGE Ø80 F T90° VR VERBINDING Ø80 VR	REF	-	E.NM-T100-80F
	€	-	58,61
T90° FEMELLE-FEMELLE-MALE T90° VR-VR-MAN	REF	E.NM-T80F	E.NM-T100F
	€	52,36	54,08
T90° MALE-MALE PIQUAGE FEMELLE T90° MAN-MAN VERBINDING VR	REF	E.NM-T80M	E.NM-T100M
	€	52,36	54,08
TAMPON DOP	REF	E.NM-B80	E.NM-B100
	€	22,77	23,49
PURGE CONDENSATIEVOER	REF	E.NM-P80	E.NM-P100
	€	25,83	26,55

COUDE - BOCHT			
COUDE 90° BOCHT 90°	REF	E.NM-C90/80	E.NM-C90/100
	€	43,55	46,34
COUDE 90° + PORTE DE VISITE BOCHT 90° + KUISDEUR	REF	E.NM-CTR80	-
	€	49,72	-
COUDE 45° BOCHT 45°	REF	E.NM-C45/80	E.NM-C45/100
	€	39,20	41,20

ACCESSOIRES - TOEBEHOREN			
MANCHON FEMELLE-FEMELLE 120MM MOF VR-VR 120MM	REF	E.NM-MFF80	E.NM-MFF100
	€	22,94	24,39
MANCHON MALE-MALE 130MM MOG MAN-MAN 130MM	REF	E.NM-MMM80	E.NM-MMM100
	€	12,02	12,75
TERMINAL DE PROTECTION INOX MALE HORIZONTAAL UITLAATSTUK INOX MAN	REF	IS-TERM80M	IS-TERM100M
	€	21,90	26,40
TERMINAL DE PROTECTION INOX FEM HORIZONTAAL UITLAATSTUK INOX VR	REF	IS-TERM80F	IS-TERM100F
	€	22,80	27,60
COLLIER MURAL RÉGLABLE REGBARE MUURBEUGEL	REF	E.NM-CMR80	E.NM-CMR100
	€	13,78	13,78
COLLIER MURAL MUURBEUGEL	REF	E.NM-CM80	E.NM-CM100
	€	13,78	13,78
COLLIER MURAL TIGE CHROMÉE MUURBEUGEL + SCHROEF IN CHROOM	REF	E.NM-COL80	E.NM-COL100
	€	24,75	24,75
ROSACE PLATE AVEC JOINT SCHOUWPLAAT MET DICHTINGSRING	REF	E.NM-RP80	E.NM-RP100
	€	10,44	12,89
PLAQUE DE FINITION NOIRE 0-30° AFWERKINGSPLAAT 0-30° ZWART	REF	E.NM-PF80N0	E.NM-PF100N0
	€	42,63	50,14
PLAQUE DE FINITION NOIRE 30-45° AFWERKINGSPLAAT 30-45° ZWART	REF	E.NM-PF80N30	E.NM-PF100N30
	€	44,20	55,51
ROSACE SILICONE NOIRE ZWART SILICON SCHOUWPLAAT	REF	RCN-80	RCN-100-
	€	6,00	8,00

2270-CPD-047

EN 1856-2-T450-N1-W-V2-L80050-G (375) NM AVEC JOINT FIBRE • MET VEZEL DICHTINGSRING
EN 1856-2-T250-P2-W-V2-L80050-0 (50) M AVEC JOINT • MET DICHTINGSRING



E.NM-∅*100 E.NM-∅*50 E.NM-∅*33 E.NM-∅*16 E.NM-TEL∅



E.NM-T100-80F



E.NM-T∅F



E.NM-T∅M



E.NM-B∅



E.NM-P∅



E.NM-C90/∅



E.NM-C45/∅



E.NM-CTR∅



E.NM-MFF∅



E.NM-MMM∅



IS-TERM∅M



IS-TERM∅F

JOINT - DICHTINGSRING

JOINT FIBRE 450 C° DICHTINGSRING VEZEL 450C°	REF	E.NM-JF80	E.NM-JF100
	€	5,58	6,09
JOINT SILICONE 250 C° SILICONE DICHTINGSRING 250 C°	REF	E.NM-J80	E.NM-J100
	€	4,59	5,27
JOINT VITTON 300 C° VITTON DICHTINGSRING 300 C°	REF	ENMJV80	ENMJV100
	€	5,26	5,99



E.NM-JF∅



E.NM-J∅



JV∅

RÉDUCTION • REDUCTIE

∅ 80			∅ 100		
∅	REF	€	∅	REF	€
100 / 80	E.NM-RD100-80	37,52	80 / 100	E.NM-RD80-100	37,52
125 / 80	E.NM-RD125-80	41,10	125 / 100	E.NM-RD125-100	41,10
153 / 80	E.NM-RD153-80	44,10	153 / 100	E.NM-RD153-100	44,10

1^{er} ∅ FEMELLE - 2^{ème} ∅ MALE • 1^{er} VROUW ∅ - 2^{de} MAN ∅

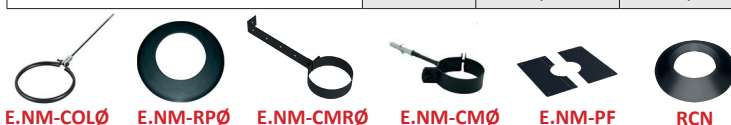

E.NM-COL∅

E.NM-RP∅

E.NM-CMR∅

E.NM-CM∅

E.NM-PF

RCN



- CONDUIT DOUBLE-PAROI ISOLÉ ALLIANT CONFORT EXCEPTIONNEL AU MONTAGE ET PERFORMANCE D'ÉTANCHÉITÉ
- DUBBELWANDIG GEÏSOLEERDE BUIS MET EENVOUDIG PLAATSING EN HOGE AFDICHTING PRESTATIES



- Application principale - hoofdtoepassing :

- Tout types de générateur (y compris condensation et basse Température)
- Alle branden (condensatie en lage temperatuur inbegrepen)

- Installation dans - plaatsing :

- Batiments individuels | - Prive woningen
- Petit collectif | - Kleine appartementen gebouwen
- Grand collectif | - Groote appartementen gebouwen
- Industrie tertiaire | - Industrie

- Combustible - brandstof :

- Bois | - Hout
- Fioul | - Olie
- Gaz | - Gas
- Charbon | - Kool
- Pellet

- Composition configuration - samenstelling :

- | | |
|--|---|
| A. Paroi extérieur (inox 304) | A. Buitenwand (inox 304) |
| B. Paroi intérieur (inox 316L) | B. Binnewand (inox 316L) |
| C. Isolant 30mm, 140kg/m ³ (laine de roche) | C. Isolatie 30mm, 140Kg/m ³ (rookwool) |
| D. Bouchon de laine de roche, haute densité 30mm | D. Rookwool doppen, hogte dichtheid 30mm |
| E. Collier de jonction large extra plat | E. Extra dun klemband |

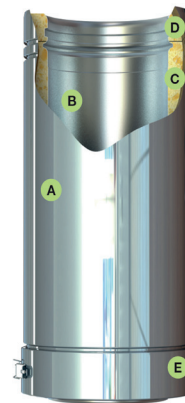

ØINTERIEUR - BINNEN	130	150	180	200	250
ØEXTERIEUR - BUITEN	190	210	240	260	310
CARACTÉRISTIQUES TECHNIQUES - PTR 30 - TECHNISCHE KENMERKEN					
PAROI INTÉRIEURE - BINNEWAND	INOX 316L 4/10				
PAROI EXTÉRIEURE - BUITENWAND	INOX 304 4/10				
ISOLATION - ISOLATIE	LAINE DE ROCHE - ROOKWOOL 140KG/M ³ + BOUCHONS - DOP 140KG/M ³				
ÉPAISSEUR ISOLANT - ISOLATIE DIKTE	30 MM				
EMBOITEMENT - INEENSCHUIVING	70 MM				
COLLIER DE JONCTION - KLEMBAND	À GRENOUILLÈRE - CLIPS (fourni avec chaque élément- inbegrepen)				
JOINT - DICHTINGSRING	SILICONE (à commander - op bestelling)				
RU	0,51 M ² K/W**				
CLASSIFICATION - CLASSIFICATIE	T450 N1 W Vm L50040 G50 - T450 N1 WT Vm L50040 G80 (selon DTU 24.1) T200 P1 W Vm L50040 020				

● ZOOM :

- Nous proposons désormais 2 solutions de dépassement pour les installations en PTR30
- Wij stellen voortaan 2 overloop oplossingen voor de installatie in PTR30 voor

- Jusque 1,50m, utilisation possible du collier de dépassement :
- Tot 1,50m, gebruik van de klemband



- De 1,50m à 3m, haubannage classique ou kit de non-haubannage :
- Van 1,50m tot 3m, gewoon tuiddraad of extra breed kelmband

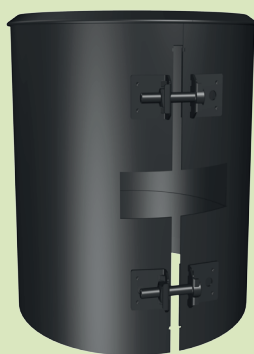







+ PRODUITS - + PRODUCT :

- Collier noyé dans le conduit : design de pointe en conduit apparent, inox ou laqué.
- Klembanden in dezelfde plan met buitenwand : Top design voor zichtbare producten in inox of gelakte.
- Emboitement sur 70mm - collier large à grenouillère : excellente étanchéité et rigidité.
- Ineenschuiving van 70mm + klemband met clips : Uitzonderlijk dichtheid en stabiliteit.
- Continuité de l'isolant, collier mettant en pression l'isolant : pas de pont thermique
- Continue isolatie, gedrukt door klemband : geen koude brug
- Paroi intérieure en saillie : facilite le centrage, emboitement facile
- Een uitstekende binnenwand : vergemakkelijkt het uitrichten, gemakkelijk ineenschuiving.

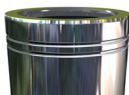
BON A SAVOIR - TIPS :

- Joint silicone : il confère au PTR sa classification **P1** en classe de t° **T200 C°**
- Silicone dichtingsring Geeft **P1** classificatie aan de PTR gamme met t° classe **T200 C°**
- En application bois : utiliser le PTR **sans joint**.
- Hout installatie Gebruik de PTR **zonder silicone dichtingsring**
- Le Ø130 est disponible pour les générateurs Pellet : pour celle-ci, utiliser le **joint fibre**
- Diam 130mm is beschikbaar voor pellets stove : Gebruik dit met de **fibering**.

FINITIONS DISPONIBLES - BESCHIKBARE AFWERKINGEN

● STANDARD : EN STOCK - OP VOORRAAD						● SPÉCIALE : SUR COMMANDE - OP BESTELLING							
INOX						CUIVRE - KOPER							
													
● LAQUÉS - GELAKT													
													
EXEMPLE : NOIR MAT 9005 DONKER ZWART	9005 noir foncé donker zwart	7016 gris ardoise leigrijs	7022 gris terre d'ombre ombergrijs	7037 gris poussière (pré-patiné clair) stofgrijs	7040 gris fenêtre venstergrijs	8004 brun cuivré koperbruin	8012 brun rouge (rouge tuile) roodbruin	8023 brun orangé (rouge terre cuite) oranjebruin	8017 brun chocolat (marron vieille tuile) chocolatebruin	1002 jaune sable zandgeel	1015 ivoire clair (ton pierre) licht ivoor kleuring	9001 blanc crème (blanc cassé) cremewit	9016 blanc standard verkeerswit
+ VALUE NOIR 9005			+15%			TOESLAG : ZWART 9005			+15%				
+ VALUE AUTRES COLORIS			+30%			TOESLAG ANDERE KLEUREN			+30%				
DELAI : NOUS CONSULTER						LEVERTIJD : ONS RAADPLEGEN							

DISPONIBLE EN NOIR +15% AVEC LE CODE **IDMN** AU LIEU DE **IDMI**
 BESCHIKBAAR IN ZWART GELAKT + 15% MET **IDMN**-CODE IN PLAATS VAN **IDMI**

*Ø300 SUR COMMANDE

*Ø300 OP BESTELLING

		INOX					
		ØINT/BIN	130	150	180	200	250
LONG UTILE	LONG TOTAL	ØEXT/BUIT	190	210	240	260	310
TUBE AVEC COLLIER - BUIS MET BEUGEL							
1400 MM	1330 MM	REF	IDMI1301400	IDMI1501400	IDMI1801400	IDMI2001400	IDMI2501400
		€	145,32	153,69	177,12	189,71	-
1000 MM	930 MM	REF	IDMI1301000	IDMI1501000	IDMI1801000	IDMI2001000	IDMI2501000
		€	106,20	118,38	136,26	145,94	174,92
500 MM	430 MM	REF	IDMI130500	IDMI150500	IDMI180500	IDMI200500	IDMI250500
		€	73,27	79,64	88,58	103,86	121,12
330 MM	260 MM	REF	IDMI130330	IDMI150330	IDMI180330	IDMI200330	IDMI250330
		€	73,01	73,61	77,20	85,04	104,29
250 MM	180 MM	REF	IDMI130250	IDMI150250	IDMI180250	IDMI200250	IDMI250250
		€	66,02	71,60	77,20	85,04	91,66
RÉGLABLE 365 - 500 MM REGELBAAR		REF	IDMIAJ130	IDMIAJ150	IDMIAJ180	IDMIAJ200	IDMIAJ250
		€	83,46	94,92	105,53	119,00	176,62

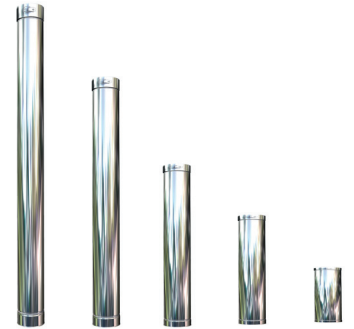

COUDE AVEC COLLIER - BOCHT MET BEUGEL						
15°	REF	IDMIC15/130	IDMIC15/15/0	IDMIC15/180	IDMIC15/200	IDMIC15/250
	€	68,08	74,60	77,49	80,51	117,73
30°	REF	IDMIC30/130/	IDMIC30/150	IDMIC30/180	IDMIC30/200	IDMC30/250
	€	74,60	77,49	80,51	91,46	117,73
45°	REF	IDMIC45/130	IDMIC45/150	IDMIC45/180	IDMIC45/200	IDMIC45/250
	€	74,60	77,49	80,51	91,46	117,73



TÉ AVEC TAMPON - T-STUK MET DOP						
90°	REF	IDMITB130	IDMITB150	IDMITB180	IDMITB200	IDMITB250
	€	150,28	171,30	186,47	206,77	228,24
135°	REF	IDMITYB130	IDMITYB150	IDMITYB180	IDMITYB200	IDMITYB250
	€	270,03	295,77	340,65	353,81	398,86



ÉLÉMENT DE RAMONAGE - BUIS MET KUISDEUR						
TÉ DE VISITE T-STUK MET KUISDEUR	REF	IDMITPV130	IDMITPV150	IDMITPV180	IDMITPV200	IDMITPV250
	€	351,42	351,42	392,60	424,15	455,46



PURGE - CONDENSATIEAFVOER						
	REF	IDMIP130	IDMIP150	IDMIP180	IDMIP200	IDMIP250
	€	52,36	54,79	67,44	72,70	74,63



COLLIER DE JONCTION - KLEMBAND						
	REF	IDMIBS130	IDMIBS150	IDMIBS180	IDMIBS200	IDMIBS250
	€	7,98	7,98	8,26	8,69	11,97



JOINT D'ÉTANCHÉITÉ - PTR - DICHTINGSRING						
	REF	IDMJ130	IDMJ150	IDMJ180	IDMJ200	IDMJ250
	€	7,95	7,95	7,95	7,95	8,77



ÉLÉMENT DE PRISE DE MESURE SUR CONDUIT - MEET ELEMENT						
	REF	IDMIMES130	IDMIMES150	IDMIMES180	IDMIMES200	IDMIMES250
	€	93,16	93,16	93,70	95,65	106,27



ACCESSOIRES - INOX - TOEBEHOREN						
*Ø300 SUR COMMANDE	ØINT/BIN	130	150	180	200	250
*Ø300 OP BESTELLING	ØEXT/BUIT	190	210	240	260	310
COLLIER MURAL RÉGLABLE - REGELBARE MUURBEUGEL						
20 À 120 MM 20 TOT 120 MM	REF	IDMIBMR130	IDMIBMR150	IDMIBMR180	IDMIBMR200	IDMIBMR250
	€	27,69	31,05	32,28	35,37	55,67
COLLIER MULTIFONCTION - TUIDRAADBEUGEL						
	REF	IDMIBH130	IDMIBH150	IDMIBH180	IDMIBH200	IDMIBH250
	€	14,60	15,06	15,06	15,06	16,95
SUPPORT MURAL DÉPART ÉLÉMENT - MUURSTEUN						
	REF	IDMISM130	IDMISM150	IDMISM180	IDMISM200	IDMISM250
	€	90,92	90,92	107,76	134,17	189,02
SUPPORT MURAL INTERMÉDIAIRE RAPIDE - TUSSENSTEUN						
	REF	IDMISMI130	IDMISMI150	IDMISMI180	IDMSIMI200	IDMISMI250
	€	84,96	84,96	97,00	120,71	170,11
PLAQUE DE BASE DÉPART SOL - VLOERONDERSTEUNING						
	REF	IDMIPDS130	IDMIPDS150	IDMIPDS180	IDMIPDS200	IDMIPDS250
	€	102,39	107,29	123,84	130,66	156,02
PLAQUE DE BASE ANCRAGE BOISSEAU - BASIS VOOR SCHOUWOPHOOGING						
	REF	IDMIPB130	IDMIPB150	IDMIPB180	IDMIPB200	IDMIPB250
	€	82,24	86,15	99,47	104,94	125,31
PLAQUE DE BASE ANCRAGE BOISSEAU DP/SP - SCHOUWOPHOOGING DW/EW						
	REF	IDMIPD130	IDMIPD150	IDMIPD180	IDMIPD200	IDMI250
	€	82,24	86,15	99,47	104,94	125,31

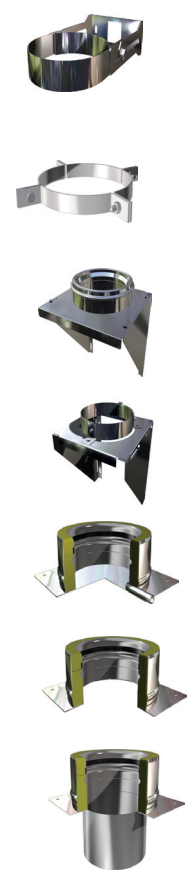

ACCESSOIRES - GALVA - TOEBEHOREN					
	130	150	180	200	250

COLLIER SOUS TOITURE - DAKONDERSTEUNING						
STANDARD	REF	IDMIST130	IDMIST150	IDMIST180	IDMIST200	IDMIST250
	€	37,30	37,30	37,30	37,30	37,30
REINFORCÉ VERSTERKTE	REF	IDMISTR130	IDMISTR150	IDMISTR180	IDMISTR200	IDMISTR250
	€	74,00	74,00	74,00	74,00	79,95



SUPPORT PLANCHER RAPIDE • VERDIEPONDERSTEUNING						
	REF	IDMISPR130	IDMISPR150	IDMISPR180	IDMISPR200	IDMISPR250
	€	46,21	46,21	50,83	58,44	77,96

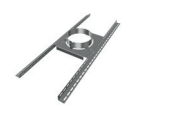

COLLIER DE SOUTIEN - ONDERSTEUNINGSBEUGEL						
	REF	IDMICS130	IDMICS150	IDMICS180	IDMICS200	IDMICS250
	€	29,83	29,83	29,83	29,83	29,83



		300 (55-300 MM)	600 (55-600 MM)
RALLONGE COLLIER MURAL - VERLENGSTUK VOOR MUURBEUGEL			
RECOUPABLE - SNIJDBARE 300 / 600 MM	REF	IDMIRBM300	IDMIRBM600
	€	70,00	82,69



RALLONGE POUR COLLIER MURAL RÉGLABLE - VERLENGSTUK VOOR MUURBEUGEL			
60 MM	REF	IDMIPC	IDMNPC (NOIR-ZWART)
	€	10,90	12,53



RALLONGE SUPP. MURAL - VERLENGSTUK VOOR MUURSTEUN			
2 PROFILS DE 980MM 2 PROFIEN VAN 980MM	REF	IDMIRSM1	
	€	62,80	



PIED SUPP. AU SOL DE CARNEAU - VOET HORIZONTAL ONDERSTEUNING	
REF	IDMNPSH
€	96,59



01 : Ø INT <230MM
03 : Ø INT >230MM

		01	03
RÉHAUSSE COLLIER CHARPENTE BOIS VERBETERINGSONDERSTEUNINGSKETING HOUT FRAME			
REF	IDMIRCS01	IDMIRCS03	
€	19,13	38,54	



02 : Ø INT <230MM
04 : Ø INT >230MM

		02	04
RÉHAUSSE COLLIER CHARPENTE BÉTON VERBETERINGSONDERSTEUNINGSKETING BETON FRAME			
REF	IDMIRCS02	IDMIRCS04	
€	19,13	38,54	



		FINITIONS INOX				
		Ø	130	150	180	200
*Ø300 SUR COMMANDE						
*Ø300 OP BESTELLING						
ÉLÉMENT DÉPART PLAFOND LONGEUR 450 MM AVEC COLLIER - DW BUIS VOOR PLAFOND AANSLUITING 450MM MET BEUGEL						
STANDARD	REF	IDMIRP130	IDMIRP150	IDMIRP180	IDMIRP200	
	€	194,50	194,50	210,71	235,02	
RÉDUIT VERKLEIND	REF	IDMIRPR130100	IDMIRPR150125	IDMIRPR180153	IDMIRPR200153	
	€	212,44	231,02	261,65	283,13	
	REF	IDMIRPR13080	IDMIRPR150100	IDMIRPR180150	IDMIRPR200150	
	€	212,44	231,02	300,33	332,28	
	REF	-	IDMIRPR15080	IDMIRPR180125	IDMIRPR200125	
€	-	231,02	300,33	332,28		
RÉDUIT SUR MESURE VERKLEIND OP MAAT	REF	IDMI RPR130XXX	IDMI RPR150XXX	IDMI RPR180XXX	IDMI RPR200XXX	
	€	276,16	300,33	332,28	368,08	
XXX = Ø À PRÉCISER - Ø TE BEVESTIGEN						

		FINITIONS LAQUÉ NOIR - ZWART GELAKT				
		Ø	130	150	180	200
ÉLÉMENT DÉPART PLAFOND LONGEUR 450 MM AVEC COLLIER - DW BUIS VOOR PLAFOND AANSLUITING 450MM MET BEUGEL						
STANDARD	REF	IDMNRP130	IDMNRP150	IDMNRP180	IDMNRP200	
	€	208,79	208,79	226,19	252,28	
RÉDUIT VERKLEIND	REF	IDMNRP130100	IDMNRP150125	IDMNRP180153	IDMNRP200153	
	€	208,79	208,79	226,20	252,29	
	REF	IDMNRP13080	IDMNRP150100	IDMNRP180150	IDMNRP200150	
	€	208,79	208,79	226,20	252,29	
	REF	-	IDMNRP15080	IDMNRP180125	-	
€	-	208,79	226,20	-		
RÉDUIT SUR MESURE VERKLEIND OP MAAT	REF	IDMN RP130XXX	IDMN RP150XXX	IDMN RP180XXX	IDMN RP200XXX	
	€	296,45	322,38	356,69	395,11	
XXX = Ø À PRÉCISER - Ø TE BEVESTIGEN						



		ROSACE POUR EDP - SCOUWPLAAT VOOR EDP			
BORD TOMBÉ AFGERONDE BOORD	REF	-	IDMIRBT150	IDMIRBT180	IDMIRBT200
	€	-	18,68	18,68	25,19
PLATE 4 TROUS PLATE	REF	IDMIR130	IDMIR150	IDMIR180	IDMIR200
	€	15,59	15,59	15,59	15,59

		ROSACE POUR EDP - SCOUWPLAAT VOOR EDP			
BORD TOMBÉ AFGERONDE BOORD	REF	-	IDMNRBT150	IDMNRBT180	IDMNRBT200
	€	-	21,48	21,48	28,97
PLATE 4 TROUS PLATE	REF	IDMNR130	IDMNR150	IDMNR180	IDMNR200
	€	17,93	17,93	17,93	17,93



		TÔLE PLAFONNIER CARRÉ - VIERKANT SCOUWPLAAT			
BORD TOMBÉ AFGERONDE BOORD	REF	IDMIRPC130	IDMIRPC150	IDMIRPC180	IDMIRPC200
	€	49,50	49,50	51,19	51,19

		TÔLE PLAFONNIER CARRÉ - VIERKANT SCOUWPLAAT			
BORD TOMBÉ AFGERONDE BOORD	REF	IDMNRPC130	IDMNRPC150	IDMNRPC180	IDMNRPC200
	€	56,92	56,92	58,87	58,87



		FIXATIONS - BEVESTIGING				
		Ø	130	150	180	200
COLLIER AIMANT - MAGNEET BEUGEL						
STANDARD	REF	IDMCOAI130	IDMCOAI150	IDMCOAI180	IDMCOAI200	
	€	25,44				



KIT DE FIXATION MAGNÉTIQUE KIT MAGNETISCHE BEVESTIGING	
REF	IDMKITAIM
€	21,34

SOLUTIONS DE DÉPASSEMENT - OVERLOOP OPLOSSINGEN		
HAUTEUR DE DÉPASSEMENT OVERLOOP HOOGTE	SOLUTIONS - OPLOSSINGEN	APERÇU - OVERZICHT
JUSQU'À - TOT 1,50 M	UTILISATION DU COLLIER GEBRUIK VAN KLEMBAND	
DE 1,50 À 3 M VOOR 1,50M TOT 3M	HAUBANNAGE CLASSIQUE - GEWOON TUIDDRAAD	
	KIT DE NON-HAUBANNAGE - EXTRA BREED E KLEMBAND	
AU DELÀ DE - BOVEN 3 M	HAUBANNAGE SELON DTU OU FABRICANT TUIDDRAAD VOLGENS DTU FABRIKANT	

		130	150	180	200	250
COLLIER DE DÉPASSEMENT - BREED E KLEMBAND						
REF	IDMIBSL130	IDMIBSL150	IDMIBSL180	IDMIBSL200	IDMIBSL250	
€	12,34	12,34	12,34	12,34	12,34	



		KIT DE NON HAUBANNAGE - EXTRA BREED E KLEMBAND				
REF	IDMIBSEL130	IDMIBSEL150	IDMIBSEL180	IDMIBSEL200	IDMIBSEL250	
€	46,30	51,11	57,11	62,51	64,50	



RACCORD SIMPLE PAROI ET FINITIONS - OVERGANGSTUK EW/DW

Ø	130	150	180	200	250
RACCORD SIMPLE STANDARD SP/DP - OVERGANGSTUK EW/DW					
REF M	IDMIASD130	IDMIASD150	IDMIASD180	IDMIASD200	IDMIASD250
€	50,88	53,94	55,69	59,51	65,32

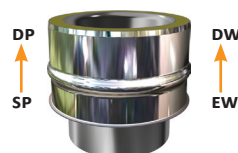

RACCORD SIMPLE INVERSÉ DP/SP - OVERGANGSTUK DW/EW					
REF	IDMIADS130	IDMIADS150	IDMIADS180	IDMIADS200	IDMIADS250
€	61,07	64,72	66,84	71,43	78,39



CACHE RACCORD COULISSANT GRAND CARRÉ - SCHUIFKANAALAFDEKING GROOT VIERKANT					
REF	IDMNCCC130	IDMNCCC150	IDMNCCC180	IDMNCCC200	IDMNCCC250
€	135,95				

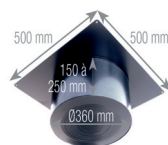

CACHE RACCORD COULISSANT GRAND ROND - SCHUIFKANAALAFDEKING GROOT ROND					
REF	IDMNCCGR130	IDMNCCGR150	IDMNCCGR180	IDMNCCGR200	IDMNCCGR250
€	135,95				

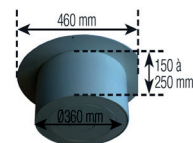

CACHE RACCORD COULISSANT PETIT ROND - SCHUIFKANAALAFDEKING KLEINE ROND					
REF	IDMNCCPR130	IDMNCCPR150	IDMNCCPR180	IDMNCCPR200	IDMNCCPR250
€	114,87				

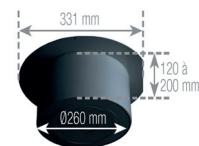

ACCESSOIRES DE TRAVERSÉE - DOORVOERFITTINGS

Ø	130	150	180	200	250
ÉLÉMENT PLAQUE DISTANCE SÉCURITÉ - BRANSEPARATIE ELEMENT					
REF	IDMEDS130	IDMEDS150	IDMEDS180	IDMEDS200	IDMEDS250
€	37,69	41,47	43,34	46,17	52,77



PLAQUE COUPE FEU - ANTI-BRANDPLAAT					
REF	IDMCF130	IDMCF150	IDMCF180	IDMCF200	IDMCF250
€	18,49	18,49	18,49	19,65	23,13

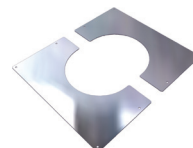

PLAQUE VENTILÉ POUR PLAFOND - VENTILATIE-PLAAT					
REF	IDMPV130	IDMPV150	IDMPV180	IDMPV200	IDMPV250
€	19,95	20,82	21,96	23,13	27,74

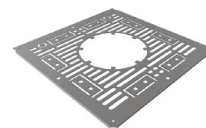

FINITIONS HAUTES - BOVEN AFWERKINGEN

Ø	130	150	180	200	250
CHAPEAU - KAP					
REF	IDMICH130	IDMICH150	IDMICH180	IDMICH200	IDMICH250
€	50,64	53,07	62,70	69,66	90,50

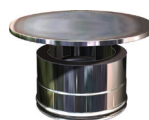

CHAPEAU ANTI-REFOULEUR - ANTI-WIND KAP					
REF	IDMICAV130	IDMICAV150	IDMICAV180	IDMICAV200	IDMICAV250
€	79,81	90,08	98,26	102,45	144,64



MITRON - CONISCH EINDSTUK					
REF	IDMIFH130	IDMIFH150	IDMIFH180	IDMIFH200	IDMIFH250
€	56,01	63,96	68,60	81,53	83,74



*Ø300 SUR COMMANDE

*Ø300 OP BESTELLING

ACCESSOIRES - INOX - TOEBEHOREN						
ØINT/BIN	130	150	180	200	250	
ØEXT/BUIT	190	210	240	260	310	

SOLINS - INOX - DAKDOORVOER

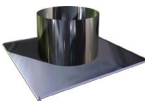
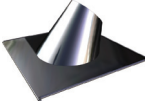
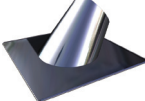
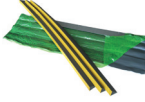
PLAT	REF	IDMISOLI130-0	IDMISOLI150-0	IDMISOLI180-0	IDMISOLI200-0	IDMISOLI250-0	
	€	78,36	78,36	78,36	78,36	96,02	
5° - 30°	REF	IDMISOLI130-5	IDMISOLI150-5	IDMISOLI180-5	IDMISOLI200-5	IDMISOLI250-5	
	€	106,97	110,37	114,53	125,65	145,65	
31° - 45°	REF	IDMISOLI130-30	IDMISOLI150-30	IDMISOLI180-30	IDMISOLI200-30	IDMISOLI250-30	
	€	116,48	121,35	126,19	134,43	151,43	
RACCORD TUILE VERBINDING OP DAKPANNEN	REF	IDMRTSOLI					
	€	46,98					

SOLINS PLOMB
DAKDOORVOER LOODSLAB

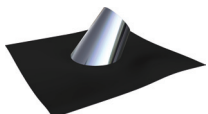
5° - 30°	REF	IDMISOLP130-5	IDMISOLP150-5	IDMISOLP180-5	IDMISOLP200-5	IDMISOLP250-5	
	€	130,80	136,50	138,09	142,80	180,60	
31° - 45°	REF	IDMISOLP130-30	IDMISOLP150-30	IDMISOLP180-30	IDMISOLP200-30	IDMISOLP250-30	
	€	138,60	146,85	154,35	158,10	192,13	

SOLINS PLOMB AVEC CONE LAQUÉ NOIR SANS LARMIER
DAKDOORVOER LOODSLAB MET CONE ZWART GELAKT EXCL. STORMKRAAG

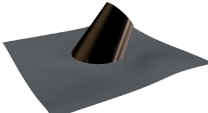
5° - 30°	REF	IDMINOLP130-5	IDMINOLP150-5	IDMINOLP180-5	IDMINOLP200-5	IDMINOLP250-5	
	€	147,72	154,61	159,32	163,02	204,35	
31° - 45°	REF	IDMINOLP130-30	IDMINOLP150-30	IDMINOLP180-30	IDMINOLP200-30	IDMINOLP250-30	
	€	156,18	166,01	170,57	180,41	231,85	

LARMIER - STORMKRAAG

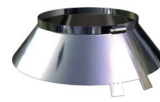
REF	IDMILA130	IDMILA150	IDMILA180	IDMILA200	IDMILA250	
€	27,79	27,79	30,11	31,27	35,91	

JOINT SILICONE POUR LARMIER - STORMKRAAG DITCHTINGSRING

REF	IDMIJLA130	IDMIJLA150	IDMIJLA180	IDMIJLA200	IDMIJLA250	
€	9,40	9,40	9,40	12,28	12,28	

KIT ISOLATION - ISOLATIE KIT						
ØINT/BIN	130	150	180	200	250	
ØEXT/BUIT	190	210	240	260	310	

KIT FOURP

ISOLATION TRAVERSÉE DE PLAFOND - PLAFOND DOORVOER ISOLATIE

	REF	IDMKITRPBO130	IDMKITRPBO150	IDMKITRPBO180	IDMKITRPBO200	IDMKITRPBO250
KIT COMPLET PLANCHER BOIS [COLLIER + RÉHAUSE] KIT HOUT VLOER	€	122,40	122,40	125,45	125,45	144,32
KIT COMPLET PLANCHER BÉTON [COLLIER + RÉHAUSE] KIT BETON VLOER	REF	IDMKITRPBE130	IDMKITRPBE150	IDMKITRPBE180	IDMKITRPBE200	IDMKITRPBE250
	€	140,09	140,09	143,17	143,17	178,81
PLAQUE ÉTANCHE DROITE + JOINT SILICONE PLAFOND PLAAT MET SILICONE DICTINGSRING	REF	IDMPEPL130	IDMPEPL150	IDMPEPL180	IDMPEPL200	IDMPEPL250
	€	55,83	55,83	55,83	57,15	62,72
FOURREAU ISOLANT [500MM] AVEC CEINTURE ISOLERENDE SCHEDE MET RIEM	REF	IDMFOP130	IDMFOP150	IDMFOP180	IDMFOP200	IDMFOP250
	€	59,76	59,76	61,53	61,53	77,40
PLAQUE DE PROPRTÉ DROITE LAQUÉ BLANCHE AVEC JOINT SILICONE WIT AFWERKINGSPLAAT + SILICONE DICHTINGSRING <i>*SUR COMMANDE - OP BESTELLING</i>	REF	IDMBPP130/0	IDMBPP150/0	IDMBPP180/0	IDMBPP200/0	IDMBPP250/0
	€	48,85	54,28	56,12	58,88	67,19
PLAQUE DE PROPRTÉ DROITE LAQUÉ NOIRE AVEC JOINT SILICONE ZWART AFWERKINGSPLAAT + SILICONE DICHTINGSRING <i>*SUR COMMANDE - OP BESTELLING</i>	REF	IDMNPP130/0	IDMNPP150/0	IDMNPP180/0	IDMNPP200/0	IDMNPP250/0
	€	48,85	54,28	56,12	58,88	67,19
PLAQUE DE DISTANCE DE SÉCURITÉ NON VENTILÉE BRANDSEPARATIE ELEMENT	REF	IDMIPE130	IDMIPE150	IDMIPE180	IDMIPE200	IDMIPE250
	€	29,52	29,52	30,65	31,81	36,42

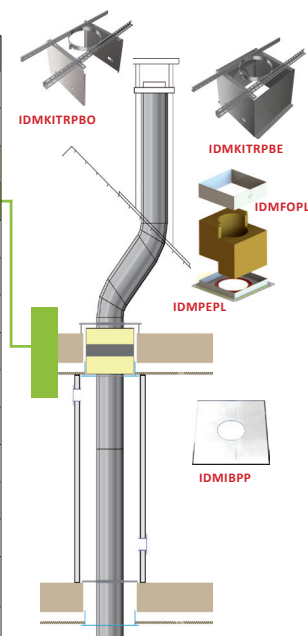

KIT ISORA

ISOLATION TRAVERSÉE DE PLAFOND EN RAMPANT - ISOLATIE VOOR DAK-HELLING

		P : 16 = 16° - 23°	P : 24 = 24° - 31°	P : 32 = 32° - 38°	P : 39 = 39° - 45°	
KIT COMPLET COMPLETE KIT	REF	IDMKITRA 130/P	IDMKITRA 150/P	IDMKITRA 180/P	IDMKITRA 200/P	IDMKITRA 250/P
	€	212,84	212,84	214,57	219,27	245,97
FOURREAU ISOLANT AVEC CEINTURE ISOLERENDE SCHEDE MET RIEM	REF	IDMFORA 130/P	IDMFORA 150/P	IDMFORA 180/P	IDMFORA 200/P	IDMFORA 250/P
	€	127,86	127,86	127,86	128,93	139,13
PLAQUE ÉTANCHE + JOINT SILICONE PLAFOND PLAAT MET SILICONE DICHTINGSRING	REF	IDMPERA 130/P	IDMPERA 150/P	IDMPERA 180/P	IDMPERA 200/P	IDMPERA 250/P
	€	60,21	60,21	60,21	61,35	63,53
PLAQUE DE PROPRTÉ SOUS RAMPANT INOX AFWERKINGSPLAAT VOOR DAK-HELLING	REF	IDMIPP130/P	IDMIPP150/P	IDMIPP180/P	IDMIPP200/P	IDMIPP250/P
	€	36,00	36,00	38,16	38,16	57,11
PLAQUE DE PROPRTÉ SOUS RAMPANT LAQUÉ NOIRE ZWART AFWERKINGSPLAAT VOOR DAK-HELLING	REF	IDMNPP130/P	IDMNPP150/P	IDMNPP180/P	IDMNPP200/P	IDMNPP250/P
	€	41,40	41,40	43,88	43,88	67,19
PLAQUE DE PROPRTÉ SOUS RAMPANT LAQUÉ BLANCHE WIT AFWERKINGSPLAAT VOOR DAK-HELLING <i>*SUR COMMANDE - OP BESTELLING</i>	REF	IDMBPP130/P	IDMBPP150/P	IDMBPP180/P	IDMBPP200/P	IDMBPP250/P
	€	42,64	42,64	45,20	45,20	69,21

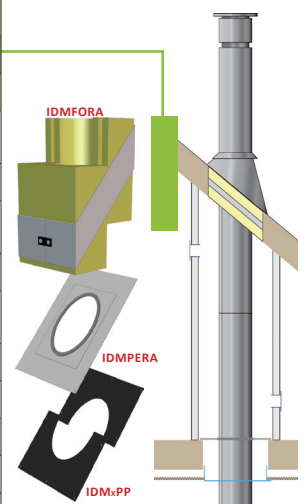

KIT ISOMU

ISOLATION TRAVERSÉE MURALE

	REF	IDMKITMU130	IDMKITMU150	IDMKITMU180	IDMKITMU200	IDMKITMU250
KIT COMPLET [INCLUT PLAQUE DE PROPRTÉ BLANCHE] COMPLETE KIT [WIT AFWERKINGSPLAAT INBEGREPEN]	€	269,64	283,03	286,45	294,07	342,94
FOURREAU ISOLANT AVEC CEINTURE ISOLERENDE SCHEDE MET RIEM	REF	IDMFOMU130	IDMFOMU150	IDMFOMU180	IDMFOMU200	IDMFOMU250
	€	78,21	81,75	81,75	81,75	83,21
PLAQUE ÉTANCHE DROITE + JOINT SILICONE PLAFOND PLAAT MET SILICONE DICHTINGSRING	REF	IDMPEMU130	IDMPEMU150	IDMPEMU180	IDMPEMU200	IDMPEMU250
	€	55,83	55,83	55,83	57,15	62,72
PLAQUE DE PROPRTÉ DROITE EN INOX RECHTE AFWERKINGSPLAAT	REF	IDMIPP130/0	IDMIPP150/0	IDMIPP180/0	IDMIPP200/0	IDMIPP250/0
	€	36,00	36,00	38,16	38,16	43,31
PLAQUE DE PROPRTÉ DROITE LAQUÉ NOIRE ZWART RECHTE AFWERKINGSPLAAT	REF	IDMNPP130/0	IDMNPP150/0	IDMNPP180/0	IDMNPP200/0	IDMNPP250/0
	€	48,85	54,28	56,12	58,88	67,19
PLAQUE DE PROPRTÉ DROITE LAQUÉ BLANCHE WIT RECHTE AFWERKINGSPLAAT <i>*SUR COMMANDE - OP BESTELLING</i>	REF	IDMBPP130/0	IDMBPP150/0	IDMBPP180/0	IDMBPP200/0	IDMBPP250/0
	€	48,85	54,28	56,12	58,88	67,19

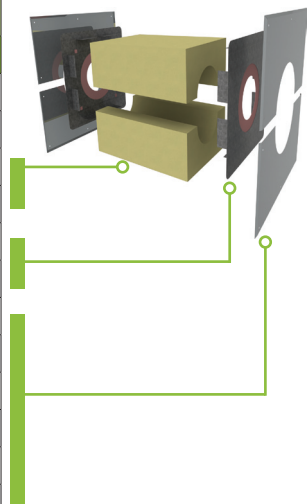

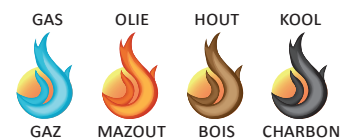

SIMPLE PAROI 316L - ENKELWANDIG 316L											
ØINT/BIN		111	125	130	139	150	153	180	200	250	300
TUBE - BUIS											
1000 MM	REF	IS66-111*100	IS66-125*100	IS66-130*100	IS66-139*100	IS66-150*100	IS66-153*100	IS66-180*100	IS66-200*100	IS66-250*100	IS66-300*100
	€	38,44	40,57	44,32	46,13	47,32	51,01	56,36	61,71	90,31	116,79
500 MM	REF	IS66-111*50	IS66-125*50	IS66-130*50	IS66-139*50	IS66-150*50	IS66-153*50	IS66-180*50	IS66-200*50	IS66-250*50	IS66-300*50
	€	22,48	22,48	23,36	26,52	26,52	31,07	32,54	34,78	52,94	68,48
330 MM	REF	IS66-111*33	IS66-125*33	IS66-130*33	IS66-139*33	IS66-150*33	IS66-153*33	IS66-180*33	IS66-200*33	IS66-250*33	IS66-300*33
	€	20,74	20,74	21,17	23,36	23,36	27,38	28,31	28,93	43,83	62,89
*REGLABLE *REGLBARE 500-885MM	REF	IS66-AJ-111	IS66-AJ-125	IS66-AJ-130	IS66-AJ-139	IS66-AJ-150	IS66-AJ-153	IS66-AJ-180	IS66-AJ-200	IS66-AJ-250	IS66-AJ-300
	€	-	81,30	83,54	87,21	93,98	93,98	108,37	127,57	155,78	179,90
* JUSQU'À ÉPUISEMENT DE STOCK • ZOLANG DE VOORRAAD STREKT											
TÉLÉSCOPIQUE SCHUIFBUIS	REF	-	IS66-TEL-125	IS66-TEL-130	-	IS66-TEL-150	-	IS66-TEL-180	IS66-TEL-200	IS66-TEL-250	-
	€	-	42,02	43,04	-	47,53	-	56,30	66,10	76,81	-



ØINT/BIN		111	125	130	139	150	153	180	200	250	300
TÉ - T-STUK											
90°	REF	IS66-T111	IS66-T125	IS66-T130	IS66-T139	IS66-T150	IS66-T153	IS66-T180	IS66-T200	IS66-T250	IS66-T300
	€	48,42	48,42	56,26	57,23	59,72	63,70	71,15	80,18	105,57	151,07
45°	REF	IS66-TY111	IS66-TY125	IS66-TY130	IS66-TY139	IS66-TY150	IS66-TY153	IS66-TY180	IS66-TY200	IS66-TY250	-
	€	-	105,45	121,93	126,32	131,80	131,80	141,70	164,76	221,88	-
TAMPON DOP	REF	IS66-B111	IS66-B125	IS66-B130	IS66-B139	IS66-B150	IS66-B153	IS66-B180	IS66-B200	IS66-B250	IS66-B300
	€	15,22	15,22	15,22	15,38	16,32	16,32	17,09	19,28	26,72	35,40
PURGE CONDENSAFVOER	REF	IS66-P111	IS66-P125	IS66-P130	IS66-P139	IS66-P150	IS66-P153	IS66-P180	IS66-P200	IS66-P250	IS66-P300
	€	20,59	20,82	20,82	21,15	22,33	22,33	23,43	24,81	30,26	37,90



ØINT/BIN		111	125	130	139	150	153	180	200	250	300
COUDE - BOCHT											
90° + PORTE 90° + KUISDEUR	REF	IS66-CTR-111	IS66-CTR-125	IS66-CTR-130	IS66-CTR-139	IS66-CTR-150	IS66-CTR-153	IS66-CTR-180	IS66-CTR-200	IS66-CTR-250	IS66-CTR-300
	€	-	69,41	70,64	71,91	74,97	77,01	89,72	100,98	127,50	-
90°	REF	IS66-C90/111	IS66-C90/125	IS66-C90/130	IS66-C90/139	IS66-C90/150	IS66-C90/153	IS66-C90/180	IS66-C90/200	IS66-C90/250	IS66-C90/300
	€	53,95	53,95	58,30	59,42	59,86	59,86	61,82	66,69	91,72	132,89
45°	REF	IS66-C45/111	IS66-C45/125	IS66-C45/130	IS66-C45/139	IS66-C45/150	IS66-C45/153	IS66-C45/180	IS66-C45/200	IS66-C45/250	IS66-C45/300
	€	37,72	37,72	40,05	40,41	41,71	41,71	42,84	43,91	62,33	92,01
30°	REF	IS66-C30/111	IS66-C30/125	IS66-C30/130	IS66-C30/139	IS66-C30/150	IS66-C30/153	IS66-C30/180	IS66-C30/200	IS66-C30/250	IS66-C30/300
	€	37,72	37,72	40,05	40,41	41,71	41,71	42,84	43,91	62,33	92,01
RÉGLABLE REGLBARE	REF	IS66-COR-111	IS66-COR-125	IS66-COR-130	IS66-COR-139	IS66-COR-150	IS66-COR-153	IS66-COR-180	IS66-COR-200	IS66-COR-250	IS66-COR-300
	€	-	-	49,47	52,02	56,10	-	66,30	75,48	100,98	139,74



ØINT/BIN		111	125	130	139	150	153	180	200	250	300
CHAPEAU - KAP											
INOX REGENKAP	REF	I-CHO-111	I-CHO-125	I-CHO-130	I-CHO-139	I-CHO-150	I-CHO-153	I-CHO-180	I-CHO-200	I-CHO-250	I-CHO-300
	€	36,55	36,55	36,55	36,55	44,72	44,72	44,72	44,72	69,63	80,10
ANTI-VENT ANTI-WIND	REF	IS66-CAV-111	IS66-CAV-125	IS66-CAV-130	IS66-CAV-139	IS66-CAV-150	IS66-CAV-153	IS66-CAV-180	IS66-CAV-200	IS66-CAV-250	IS66-CAV-300
	€	55,28	60,61	61,23	63,34	65,36	65,36	71,46	76,39	92,20	-



BRIDE DE SÉCURITÉ INCLUSE - KLEMBAND INBEGREPEN
 JOINT COMPRIS - DICHTINGSRING INBEGREPEN : Ø 60 / 80 / 100

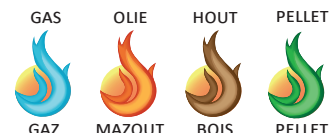

SIMPLE PAROI 316L - ENKELWANDIG 316L								
ØINT/BIN		60	80	100	130	150	180	200
TUBE - BUIS								
1000 MM	REF	IS64-60*100	IS64-80*100	IS64-100*100	IS64-130*100	IS64-150*100	IS64-180*100	IS64-200*100
	€	29,50	33,50	33,85	35,10	42,32	50,44	59,13
500 MM	REF	IS64-60*50	IS64-80*50	IS64-100*50	IS64-130*50	IS64-150*50	IS64-180*50	IS64-200*50
	€	18,00	22,50	23,13	24,11	27,48	31,49	34,69
250 MM	REF	IS64-60*33	IS64-80*33	IS64-100*33	IS64-130*33	IS64-150*33	IS64-180*33	IS64-200*33
	€	12,00	13,90	15,96	19,80	21,97	23,42	34,49
REGLABLE - REGELBARE 250-350MM	REF	-	IS64-AJ-80	IS64-AJ-100	IS64-AJ-130	IS64-AJ-150	IS64-AJ-180	IS64-AJ-200
	€	-	34,50	42,60	48,63	52,33	57,98	61,68



TÉ - T-STUK								
90° PIQUAGE MALE 90° VERBINDING MAN.	REF	IS64-T60	IS64-T80	IS64-T100	IS64-T130	IS64-T150	IS64-T180	IS64-T200
	€	35,51	38,50	40,60	45,73	50,64	51,80	61,48
90° PIQUAGE FEM. Ø80 90° VERBINDING VR. Ø80	REF	-	IS64-T80F	IS64-T100 80F	-	-	-	-
	€	-	38,50	42,00	-	-	-	-
45°	REF	-	IS64-TY80	IS64-TY100	IS64-TY130	IS64-TY150	IS64-TY180	IS64-TY200
	€	-	58,34	68,00	69,72	77,81	78,96	91,60



COUDE - BOCHT								
90° + PORTE 90° + KUISDEUR	REF	IS64-CTR-60	IS64-CTR-80	IS64-CTR-100	IS64-CTR-130	IS64-CTR-150	IS64-CTR-180	IS64-CTR-200
	€	-	65,45	74,55	89,42	99,90	102,50	104,90
90°	REF	IS64-CS90 60	IS64-CS90 80	IS64-CS90 100	IS64-CS90 130	IS64-CS90 150	IS64-CS90 180	IS64-CS90 200
	€	36,60	22,47	29,54	40,88	43,65	48,42	52,74
45°	REF	IS64-CS45 60	IS64-CS45 80	IS64-CS45 100	IS64-CS45 130	IS64-CS45 150	IS64-CS45 180	IS64-CS45 200
	€	26,38	19,30	28,21	31,71	34,76	38,00	43,65
RÉGLABLE REGLBARE	REF	-	IS64-COR80	IS64-COR100	IS64-COR130	IS64-COR150	IS64-COR180	IS64-COR200
	€	-	35,01	38,57	45,20	50,83	51,45	53,33



ACCESSOIRES - TOEBEHOREN								
ÉLÉMENT D'INSPECTION BUIS + KIJKDEUR	REF	-	IS64-EI-80	IS64-EI-100	IS64-EI-130	IS64-EI-150	IS64-EI-180	IS64-EI-200
	€	-	64,33	80,46	92,53	101,99	134,24	143,94
ÉLÉMENT DROIT + PORTE BUIS + KUISDEUR	REF	-	IS64-PV 80	IS64-PV 100	IS64-PV 130	IS64-PV 150	IS64-PV 180	IS64-PV 200
	€	-	67,55	84,49	97,15	107,09	140,95	151,14
MANCHON FEM/FEM MOF VR/VR	REF	-	IS64-M80	IS64-M100	IS64-M130	IS64-M150	IS64-M180	IS64-M200
	€	-	17,01	19,19	22,07	25,09	27,23	28,91
TAMPON DÉPRESSION DOP (ONDERDRUK)	REF	-	IS64-B80	IS64-B100	IS64-B130	IS64-B150	IS64-B180	IS64-B200
	€	-	16,12	18,04	18,38	19,91	27,57	30,64
PURGE DÉPRESSION CONDENSATVOER (ONDERDRUK)	REF	-	IS64-P80	IS64-P100	IS64-P130	IS64-P150	IS64-P180	IS64-P200
	€	-	17,69	19,35	20,41	21,89	22,97	24,32
TAMPON + POIGNÉE ÉTANCHE DOP ONDER EN OVERDRUK	REF	IS64-BP60	IS64-BP80	IS64-BP100	IS64-BP130	IS64-BP150	IS64-BP180	IS64-BP200
	€	25,64	26,69	30,47	34,91	40,13	45,19	49,61
BRIDE ARAIGNÉE AFSTANDKLEM	REF	-	IS64-BA80	IS64-BA100	IS64-BA130	IS64-BA150	IS64-BA180	IS64-BA200
	€	-	25,41	29,26	33,01	37,39	38,07	39,92
ROSACE SILICONE NOIRE ZWART SILICONE SCHOUWPLAAT	REF	RCN60	RCN80	RCN100	-	-	-	-
	€	6,00	6,00	8,00				
JOINT NOIR (T200° C) ZWART DICHTINGSRING	REF	IS66-JOINT60	IS66-JOINT80	IS66-JOINT100	IS66-JOINT130	IS66-JOINT150	IS66-JOINT180	IS66-JOINT200
	€	3,00	4,00	4,00	4,00	5,00	7,00	7,00



PRESSION OVERDRUKTE T200 P1 W V2 L50040 O30 - AVEC JOINT D'ÉTANCHÉITÉ NOIR (UTILISATION ÉTANCHE EN PRESSION)
 - MET DICHTINGRING (ONDER EN OVERDRUK)

DÉPRESSION ONDERDRUKTE

T600 N1 W V2 L50040 G - SANS JOINT D'ÉTANCHÉITÉ (UTILISATION POUR TUBAGE)
 - ZONDER DICHTINGRING (VOOR TUBAGE)

T600 N1 D V2 L50040 G500 M - SANS JOINT D'ÉTANCHÉITÉ (UTILISATION POUR RACCORDEMENT)
 - ZONDER DICHTINGRING (VOOR AANSLUITING)

ØINT/BIN		80	100	111	125	130	139	150	180	200	250	300
SOLINS - DAKDOORVOER												
LARMIER STORMKRAAG	REF	IS-LA80	IS-LA100	IS-LA111	IS-LA125	IS-LA130	IS-LA139	IS-LA150	IS-LA180	IS-LA200	IS-LA250	-
	€	18,07	18,07	-	18,07	20,34	21,16	21,16	28,73	31,63	41,45	-
SOLIN INOX PLAT INOX DAKDOORVOER PLATDAK	REF	SOLI80-0	SOLI100-0	SOLI111-0	SOLI125-0	SOLI130-0	SOLI139-0	SOLI150-0	SOLI180-0	SOLI200-0	SOLI250-0	-
	€	80,58	80,58	-	80,71	80,71	80,71	80,71	80,71	80,71	80,71	-
SOLIN INOX 5-30° INOX DAKDOORVOER 5-30°	REF	SOLI80-5	SOLI100-5	SOLI111-5	SOLI125-5	SOLI130-5	SOLI139-5	SOLI150-5	SOLI180-5	SOLI200-5	SOLI250-5	-
	€	84,58	84,58	-	100,18	100,18	100,18	103,19	106,97	110,18	117,97	-
SOLIN INOX 31-45° INOX DAKDOORVOER 31-45°	REF	SOLI80-30	SOLI100-30	SOLI111-30	SOLI125-30	SOLI130-30	SOLI139-30	SOLI150-30	SOLI180-30	SOLI200-30	SOLI250-30	-
	€	87,38	87,38	-	106,31	106,31	106,31	109,54	109,54	119,98	129,98	-
SOLIN PLOMB 5-30° LOODSLAB DAKDOORVOER 5-30°	REF	SOLP80-10	SOLP100-10	SOLP111-10	SOLP125-10	SOLP130-10	SOLP139-10	SOLP150-10	SOLP180-10	SOLP200-10	SOLP250-10	SOLP300-10
	€	98,32	98,32	-	108,30	108,30	108,30	108,30	130,80	136,50	147,56	186,62
SOLIN PLOMB 31-45° LOODSLAB DAKDOORVOER 31-45°	REF	SOLP80-25	SOLP100-25	SOLP111-25	SOLP125-25	SOLP130-25	SOLP139-25	SOLP150-25	SOLP180-25	SOLP200-25	SOLP250-25	SOLP300-25
	€	104,75	104,75	-	117,00	117,00	117,00	117,00	138,80	146,85	163,37	213,13



IS-LA-Ø

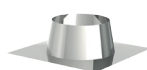

SOLIØ-0

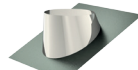

SOLIØ-10

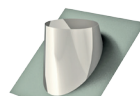

SOLIØ-25

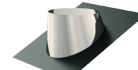

SOLPØ-10

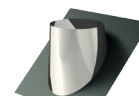

SOLPØ-25

ØINT/BIN		80	100	111	125	130	139	150	180	200	250	300
ACCESSOIRES - TOEBEHOREN												
BRIDE DE SÉCURITÉ KLEMBAND	REF	IS-BS80	IS-BS100	-	IS-BS125	IS-BS130	IS-BS139	IS-BS150	IS-BS180	IS-BS200	IS-BS250	IS-BS300
	€	6,00	6,00	-	6,00	6,00	6,00	6,00	6,00	6,50	7,00	8,00
BRIDE MURALE MUURBEUGEL	REF	IS-BM80	IS-BM100	IS-BM111	IS-BM125	IS-BM130	IS-BM139	IS-BM150	IS-BM180	IS-BM200	IS-BM250	IS-BM300
	€	16,63	17,38	17,46	18,63	18,63	19,18	20,63	22,40	24,14	37,54	41,80
BRIDE MURALE RÉGLABLE REGBARE MUURBEUGEL	REF	IS-BMR80	IS-BMR100	IS-BMR111	IS-BMR125	IS-BMR130	IS-BMR139	IS-BMR150	IS-BMR180	IS-BMR200	IS-BMR250	IS-BMR300
	€	27,91	27,91	-	30,05	31,48	32,37	32,37	32,91	35,76	65,03	71,26
SUPPORT AU TOIT DAKSTEUN	REF	-	-	IS-ST111	IS-ST125	IS-ST130	IS-ST139	IS-ST150	IS-ST180	IS-ST200	IS-ST250	IS-ST300
	€	-	-	-	30,71	31,26	31,50	32,35	33,92	36,55	37,15	39,81
BRIDE DE HAUBANAGE TUIDDRAAD	REF	-	-	IS-BH111	IS-BH125	IS-BH130	IS-BH139	IS-BH150	IS-BH180	IS-BH200	IS-BH250	IS-BH300
	€	-	-	21,92	21,92	24,64	24,64	24,64	24,64	26,02	28,77	28,77
RALLONGE 600MM VERLENGSTUK 600MM	REF	IS-RAL										
	€	43,20										
RALLONGE 750MM VERLENGSTUK 750MM	REF	IS-RAL 75										
	€	54,87										



IS-BS-Ø



IS-BM-Ø



IS-BMR-Ø



IS-ST-Ø



IS-BH-Ø

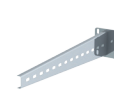

IS-RAL

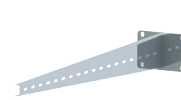

IS-RAL75

ØINT/BIN		80	100	111	125	130	139	150	180	200	250	300
FINITIONS - AFWERKING												
ROSACE SCHOUWPLAAT	REF	I-R80	I-R100	I-R111	I-R125	I-R130	I-R139	I-R150	I-R180	I-R200	I-R250	I-R300
	€	14,21	16,69	17,19	17,19	17,19	17,19	17,19	22,57	24,19	27,62	33,15
PLAQUE DE DÉPART SCHOUWOPHOOGING	REF	-	-	IS-PD111	IS-PD125	IS-PD130	IS-PD139	IS-PD150	IS-PD180	IS-PD200	IS-PD250	IS-PD300
	€	-	-	-	69,08	70,44	70,44	74,59	78,74	92,57	122,96	-
SUPPORT MURAL MUURSTEUN	REF	IS-SM80	IS-SM100	IS-SM111	IS-SM125	IS-SM130	IS-SM139	IS-SM150	IS-SM180	IS-SM200	IS-SM250	IS-SM300
	€	-	-	-	70,28	70,28	71,33	72,22	78,09	83,41	108,24	120,68



I-R-Ø

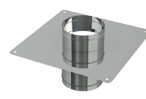

IS-PD-Ø



IS-SM-Ø

INOX 316L		Ø MALE • MAN Ø													
Ø		80	100	111	125	130	139	150	153	180	200	230	250	300	
Ø FEMELLE • VROUW Ø	80	REF		IS64-R 80-100	IS64-R 80-111	IS64-R 80-125	IS64-R 80-130	-	IS64-R 80-150	-	IS64-R 80-180	-	-	-	-
		€		39,32	39,32	40,68	40,68		42,60		54,62				
	100	REF	IS64-R 100-80		IS64-R 100-111	IS64-R 100-125	IS64-R 100-130	-	IS64-R 100-150	-	-	-	-	-	-
		€	39,32		39,32	43,97	43,97		43,97						
	111	REF	IS64-R 111-80	IS64-R 111-100		IS64-R 111-125	IS64-R 111-130	IS64-R 111-139	IS64-R 111-150	IS64-R 111-153	-	-	-	-	-
		€	39,32	39,32		32,69	36,24	36,24	36,24	36,24					
	125	REF	IS64-R 125-80	IS64-R 125-100	IS64-R 125-111		IS64-R 125-130	IS64-R 125-139	IS64-R 125-150	IS64-R 125-153	IS64-R 125-180	-	-	-	-
		€	39,32	43,97	32,69		32,69	33,44	36,24	36,24	36,24				
	130	REF	IS64-R 130-80	IS64-R 130-100	IS64-R 130-111	IS64-R 130-125		IS64-R 130-139	IS64-R 130-150	IS64-R 130-153	IS64-R 130-180	-	-	-	-
		€	39,32	39,32	36,24	33,00		32,69	36,24	36,24	39,49				
	139	REF	-	IS64-R 139-100	IS64-R 139-111	IS64-R 139-125	IS64-R 139-130		IS64-R 139-150	IS64-R 139-153	IS64-R 139-180	-	-	-	-
		€		50,65	36,88	33,44	32,69		37,77	37,77	39,49				
	150	REF	IS64-R 150-80	IS64-R 150-100	IS64-R 150-111	IS64-R 150-125	IS64-R 150-130	IS64-R 150-139		-	IS64-R 150-180	IS64-R 150-200	-	-	-
		€	42,60	42,60	36,24	36,24	36,24	37,77			41,98	43,59			
	153	REF	IS64-R 153-80	IS64-R 153-100	IS64-R 153-111	IS64-R 153-125	IS64-R 153-130	IS64-R 153-139	-		IS64-R 153-180	IS64-R 153-200	-	-	-
		€	42,60	42,60	36,24	36,24	39,07	37,77			41,98	43,59			
180	REF	IS64-R 180-80	IS64-R 180-100	-	IS64-R 180-125	IS64-R 180-130	IS64-R 180-139	IS64-R 180-150	IS64-R 180-153		IS64-R 180-200	IS64-R 180-230	IS64-R 180-250	-	
	€	53,53	53,53		41,98	41,98	41,98	41,98	41,98		43,59	87,14	87,14		
200	REF	IS64-R 200-80	-	-	IS64-R 200-125	IS64-R 200-130	IS64-R 200-139	IS64-R 200-150	IS64-R 200-153	IS64-R 200-180		IS64-R 200-230	IS64-R 200-250	IS64-R 200-300	
	€	97,48			65,26	65,26	43,59	43,59	43,59	43,59		87,14	87,14	97,48	
230	REF	-	-	-	IS64-R 230-125	-	-	-	IS64-R 230-153	IS64-R 230-180	IS64-R 230-200		IS64-R 230-250	IS64-R 230-300	
	€				97,48				97,48	97,48	87,14		87,14	97,48	
250	REF	-	-	-	IS64-R 250-125	-	-	-	-	IS64-R 250-180	IS64-R 250-200	IS64-R 250-230		IS64-R 250-300	
	€				97,48					87,14	87,14	87,14		97,48	
300	REF	-	-	-	-	-	-	-	-	-	IS64-R 300-200	IS64-R 300-230	IS64-R 300-250		
	€										97,48	97,48	97,48		

1^{ER} Ø FEMELLE - 2^{EME} Ø MALE • 1ST VROUW Ø - 2^{DE} MAN Ø



INOX 316L		REDUCTIONS AVEC JOINTS • REDUCTIE MET DICHTINGSRING																		
Ø		Ø MALE • MAN Ø																		
		80	100	125	130	150	180	200		80	100	125	130	150	180	200	250			
Ø FEMELLE • VROUW Ø	80	REF		IS64RJ 80-80	IS64RJ 80-100	IS64RJ 80-125	IS64RJ 80-130	IS64RJ 80-150	IS64RJ 80-180	IS64RJ 80-200	150	REF	IS64RJ 150-80	IS64RJ 150-100	IS64RJ 150-125	IS64RJ 150-130		IS64RJ 150-180	IS64RJ 150-200	IS64RJ 150-250
		€		40,07	40,39	40,72	43,37	55,09	97,08			€	44,37	45,37	49,35	49,42		66,32	73,31	*
	100	REF	IS64RJ 100-80		IS64RJ 100-125	IS64RJ 100-130	IS64RJ 100-150	IS64RJ 100-180	IS64RJ 100-200		180	REF	IS64RJ 180-80	IS64RJ 180-100	IS64RJ 180-125	IS64RJ 180-130	IS64RJ 180-150		IS64RJ 180-200	IS64RJ 180-250
		€	41,78		41,87	42,30	47,65	*	*			€	59,50	*	60,73	60,73	68,60		83,72	104,21
	125	REF	IS64RJ 125-80	IS64RJ 125-100		IS64RJ 125-130	IS64RJ 125-150	IS64RJ 125-180	IS64RJ 125-200		200	REF	IS64RJ 200-80	IS64RJ 200-100	IS64RJ 200-125	IS64RJ 200-130	IS64RJ 200-150	IS64RJ 200-180		IS64RJ 200-250
		€	41,78	43,97		46,54	49,35	58,50	*			€	97,48	*	*	*	75,84	83,72		110,06
	130	REF	IS64RJ 130-80	IS64RJ 130-100	IS64RJ 130-125		IS64RJ 130-150	IS64RJ 130-180	IS64RJ 130-200		250	REF					IS64RJ 250-150	IS64RJ 250-180	IS64RJ 250-200	
		€	42,12	42,30	46,54		51,12	58,71	*			€					110,06	110,06	110,06	

1^{ER} Ø FEMELLE - 2^{EME} Ø MALE • 1ST VROUW Ø - 2^{DE} MAN Ø

* SUR DEVIS • OP BESTEK

ØINT/BIN		97	111	125	139	153	180	200
TUBE - BUIS								
1000 MM	REF	E.NM 97*100	E.NM 111*100	E.NM 125*100	E.NM 139*100	E.NM 153*100	E.NM 180*100	E.NM 200*100
	€	24,44	26,45	28,77	30,16	36,26	52,36	58,50
500 MM	REF	E.NM 97*50	E.NM 111*50	E.NM 125*50	E.NM 139*50	E.NM 153*50	E.NM 180*50	E.NM 200*50
	€	13,64	14,39	17,29	18,48	23,94	29,17	32,62
330 MM	REF	E.NM 97*33	E.NM 111*33	E.NM 125*33	E.NM 139*33	E.NM 153*33	E.NM 180*33	E.NM 200*33
	€	11,37	11,76	13,40	14,72	17,83	23,76	25,86
COULISSANT 500MM + BAGUE REGELBARE 500MM + BEUGEL	REF	E.NM-TEL 97	E.NM-TEL 111	E.NM-TEL 125	E.NM-TEL 139	E.NM-TEL 153	E.NM-TEL 180	E.NM-TEL 200
	€	-	-	24,53	25,73	31,21	36,61	40,08



ØINT/BIN		97	111	125	139	153	180	200
COUDE - BOCHT • TÉ - T-STUK								
90°	REF	E.NM-C90 97	E.NM-C90 111	E.NM-C90 125	E.NM-C90 139	E.NM-C90 153	E.NM-C90 180	E.NM-C90 200
	€	22,71	24,31	26,69	28,26	33,82	44,74	50,98
45°	REF	E.NM-C45 97	E.NM-C45 111	E.NM-C45 125	E.NM-C45 139	E.NM-C45 153	E.NM-C45 180	E.NM-C45 200
	€	22,71	24,31	26,69	28,26	33,82	44,74	50,98
90° + PORTE * 90° + KUISDEUR * <small>* SUR COMMANDE - OP BESTELLING</small>	REF	E.NM-CTR97	E.NM-CTR111	E.NM-CTR125	E.NM-CTR139	E.NM-CTR153	E.NM-CTR180	E.NM-CTR200
	€	-	-	60,66	65,80	67,62	83,75	101,36
TÉ 90° + BOUCHON T-STUK 90° + DOP	REF	E.NM-T 97	E.NM-T 111	E.NM-T 125	E.NM-T 139	E.NM-T 153	E.NM-T 180	E.NM-T 200
	€	38,17	38,44	39,02	44,03	50,66	73,73	81,43



ØINT/BIN		97	111	125	139	153	180	200
ACCESSOIRES - TOEBEHOREN								
ROSACE SCHOUWPLAAT	REF	E.NM-R 97	E.NM-R 111	E.NM-R 125	E.NM-R 139	E.NM-R 153	E.NM-R 180	E.NM-R 200
	€	12,10	12,37	12,62	12,98	14,29	21,78	22,87
ROSACE Ø500 EXT SCHOUWPLAAT Ø500 BUITEN	REF	E.NM-PP 97500N	E.NM-PP 111500N	E.NM-PP 125500N	E.NM-PP 139500N	E.NM-PP 153500N	E.NM-PP 180500N	E.NM-PP 200500N
	€	-	-	-	-	57,31	57,31	68,77
RACCORD FEM/FEM 120MM MOF VR/VR 120MM	REF	E.NM-RC 97	E.NM-RC 111	E.NM-RC 125	E.NM-RC 139	E.NM-RC 153	E.NM-RC 180	E.NM-RC 200
	€	9,80	10,08	10,43	12,30	14,47	17,53	21,03
COLLIER MURAL TIGE CHROMÉE 250MM MUURBEUGEL + SCHROEF IN CHROOM 250MM	REF	E.NM-COL97	E.NM-COL111	E.NM-COL125	E.NM-COL139	E.NM-COL153	E.NM-COL180	E.NM-COL200
	€	24,30	24,30	24,30	24,30	24,30	26,05	27,90
RACCORD ANTI-BISTRE KACHEL AANSLUITING	REF	E.NM-RAB97	E.NM-RAB111	E.NM-RAB125	E.NM-RAB139	E.NM-RAB153	E.NM-RAB180	E.NM-RAB200
	€	-	-	31,89	33,46	35,08	43,17	46,21

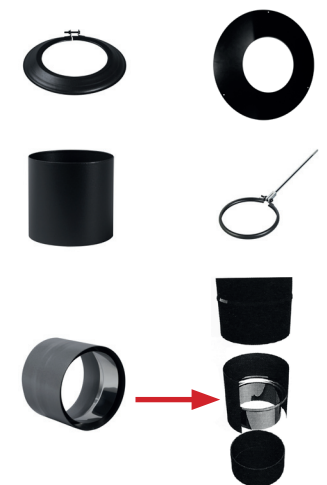

RÉDUCTIONS • REDUCTIE								
Ø	REF	€	Ø	REF	€	Ø	REF	€
125 / 111	E.NMRD125111	22,88	153 / 125	E.NMRD153125	39,57	180 / 153	E.NMRD180153	41,75
139 / 125	E.NMRD139125	22,50	153 / 139	E.NMRD153139	24,96	200 / 153	E.NMRD200153	43,42
153 / 97	E.NMRD15397	43,45	153 / 150	E.NM-M153*	23,02	*ENM-M153 = 153F/V --> 150M		
153 / 111	E.NMRD153111	43,42	180 / 125	E.NMRD180125	43,02	200 / 180	E.NMRD200180	41,14

1^{ER} Ø FEMELLE - 2^{ÈME} Ø MALE • 1ST VROUW Ø - 2^{DE} MAN Ø



ØINT/BIN		125	153	180
ACCESSOIRES - TOEBEHOREN				
BUSE AVEC DÉCALAGE 75MM BUIS MET VERSLEPING 75MM	REF	E.NM-DEC75-125	E.NM-DEC75-153	E.NM-DEC75-180
	€	57,69	60,57	71,83
BUSE AVEC DÉCALAGE 150MM BUIS MET VERSLEPING 150MM	REF	E.NM-DEC150-125	E.NM-DEC150-153	E.NM-DEC150-180
	€	70,88	74,42	85,68



Système de raccordement pour poêle à bois Ø150 et Ø153 mm

Verbinding voor hout kachel Ø150 en Ø153 mm

FABRICATION FRANCAISE
FRANS FRABRICATIE



- Montage télescopique facile et rapide à mettre en place :
- distance min. 108cm / max. 188 cm

- Système conçu :
- pour un branchement au-dessus du poêle
- et un raccordement plafond

- Esthétique :
- continuité parfaite du raccordement
- en acier émail noir mat résistant

- Permet la restitution de chaleur dans la pièce

- Option :
- bague inox large isolée

- Système combinant :
- 2 longueurs télescopiques
- 1 adaptateur anti-bistre

- Snelle en eenvoudige telescopische montage :
- min. afstand 108cm / max. 188 cm

- Ontworpen systeem :
- voor een aansluiting boven het kachel
- en plafondaansluiting

- Esthetiek :
- perfect continuïteit van de verbinding
- email zwart mat staal resistent

- Straalt de warmte uit in de kamer

- Optie :
- inox breede klemband geïsoleerd

- Combinatie van :
- 2 telescopische lengtes
- 1 kachel aansluiting

VERSION STANDARD
STANDAARD VERSIE

2 longueurs émail noir mat
2 lengten email zwart
+
1 élément anti-bistre
1 kachel aansluiting

Ø150 - 153 - 180
REF : ENMKN Ø

€ : 89,00

Option : 1 bague inox
Optie : 1 inox klemband
REF : ENMBI Ø

€ : 22,00



ØINT/BIN		80	125	139	150	180	200
RACCORD POÊLE/CONDUIT - KOPPELSTUKKEN KACHEL/BUIS							
20*20 [A=30CM - B=30CM] BLANC - WIT	REF	017-RP20-80B	017-RP20-125B	017-RP20-139B	017-RP20-150B	017-RP20-180B	017-RP20-200B
	€	66,30	89,73	89,73	89,73	89,73	-
20*20 [A=30CM - B=30CM] NOIR - ZWART	REF	017-RP20-80N	017-RP20-125N	017-RP20-139N	017-RP20-150N	017-RP20-180N	017-RP20-200N
	€	66,30	89,73	89,73	89,73	89,73	-
25*25 [A=35CM - B=35CM] BLANC - WIT	REF	017-RP25-80B	017-RP25-125B	017-RP25-139B	017-RP25-150B	017-RP25-180B	017-RP25-200B
	€	68,85	95,37	95,37	95,37	95,37	95,37
25*25 [A=35CM - B=35CM] NOIR - ZWART	REF	017-RP25-80N	017-RP25-125N	017-RP25-139N	017-RP25-150N	017-RP25-180N	017-RP25-200N
	€	68,85	95,37	95,37	95,37	95,37	95,37
30*30 [A=40CM - B=40CM] BLANC - WIT	REF	017-RP30-80B	017-RP30-125B	017-RP30-139B	017-RP30-150B	017-RP30-180B	017-RP30-200B
	€	103,32	103,32	103,32	103,32	103,32	103,32
30*30 [A=40CM - B=40CM] NOIR - ZWART	REF	017-RP30-80N	017-RP30-125N	017-RP30-139N	017-RP30-150N	017-RP30-180N	017-RP30-200N
	€	103,32	103,32	103,32	103,32	103,32	103,32

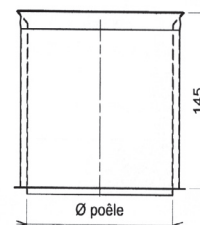
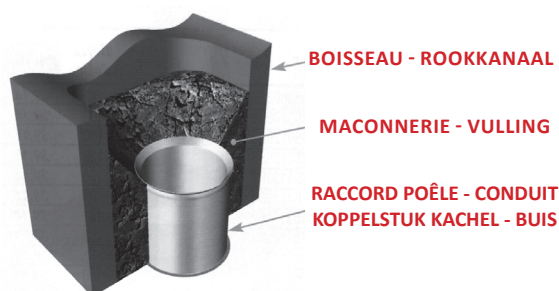
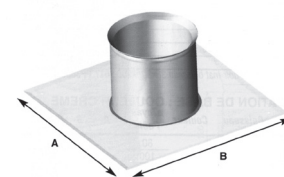

ØINT/BIN		80	100	112	120	125	130	140	150	167	180	200	250
FLEXIBLE INOX - INOX FLEXIBEL													
SP-EW 316L	REF	FIS-80	FIS-100	FIS-112	FIS-120	FIS-125	FIS-130	FIS-140	FIS-150	FIS-167	FIS-180	FIS-200	FIS-250
	€	19,09	21,64	22,09	24,08	24,61	26,52	27,56	29,13	31,55	38,42	46,42	63,13
DP-DW 316L	REF	FID-80	FID-100	FID-112	FID-120	FID-125	FID-130	FID-140	FID-150	FID-167	FID-180	FID-200	FID-250
	€	32,42	35,81	36,66	39,03	40,06	43,70	44,55	48,60	55,00	56,50	64,06	84,00
DP-DW 904L	REF	F19-80	F19-100	F19-112	F19-120	F19-125	F19-130	F19-140	F19-150	F19-167	F19-180	F19-200	F19-250
	€	-	-	-	-	76,16	82,23	83,39	91,81	102,93	107,57	135,28	180,05

Ø90 - 154 SUR COMMANDE • Ø90 - 154 OP BESTELLING

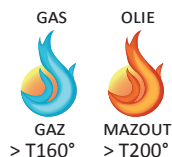
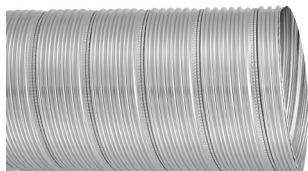

FIS

SP 316L • EW 316L

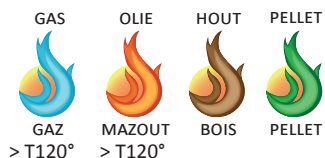
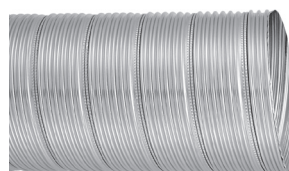

FID

DP LISSE INTÉRIEUR 316L • DW GLADDE BINNENWAND 316L

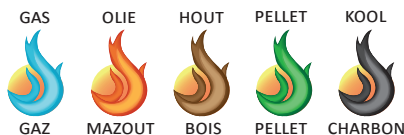
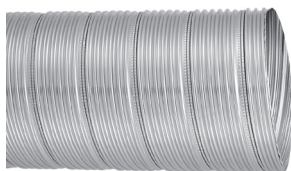

F19

DP LISSE INTÉRIEUR 904L • DW GLADDE BINNENWAND 904L

	80	100	112	120	125	130	140	150	167	180	200	250
CONDITIONNEMENT SP (EN MÈTRE) - VERPAKING EW (METER)												
TOURET METALLIQUE METALSTEUN HASPEL	100	100	100	-	100	100	100	100	-	60	60	30
DÉVIDOIR - AFROLLER	60	40	40	40	40	40	40	30	30	30	30	-
CONDITIONNEMENT DP (EN MÈTRE) - VERPAKING DW (METER)												
TOURET METALLIQUE METALSTEUN HASPEL	100	100	100	-	100	100	100	100	-	60	60	30
DÉVIDOIR - AFROLLER	60	40	40	40	40	40	40	30	30	30	30	-



TOURET METALLIQUE METALSTEUN HASPEL



DEVIDOIR • AFROLLER

* Ø 90, Ø120, Ø154 JUSQU'À ÉPUISEMENT DE STOCK • ZOLANG DE VOORRAAD STREKT Ø90, Ø120, Ø154

Ø INTÉRIEUR • BINNEN Ø		80	90*	100	111	120*	125	130	139	150	154	167	180	200	250
DESCRIPTION • BESCHRIJVING	REF	€	€	€	€	€	€	€	€	€	€	€	€	€	€
TÉ 316 + PURGE • T-STUK 316 MET CONDENS	FIS-T6-Ø	-	80,01	-	-	-	102,98	108,63	108,56	113,72	113,72	132,18	132,18	145,00	175,96
TÉ 304 + PURGE • T-STUK 304 MET CONDENS	FIS-T4-Ø	66,57	66,57	53,65	61,03	66,88	70,23	73,06	73,12	77,76	77,76	87,40	91,77	99,73	-
TÉ 316 135° + PURGE T-STUK 316 135° MET CONDENS	FIS-TY6-Ø	-	-	-	-	-	124,26	130,66	-	137,92	-	-	-	-	-
PLAQUE D'OBTURATION • AFDEKPLAAT	FIS-PO-Ø	20,50	20,50	20,81	20,81	20,81	20,81	20,81	21,82	-->	21,82	21,82	21,82	21,82	-
PLAQUE D'OBTURATION 40 * 40 AFDEKPLAAT 40 * 40	FIS-PO-Ø/40	33,25	-	33,09	33,09	33,09	33,09	33,09	36,03	-->	36,03	36,03	36,03	36,03	36,03
COLLIER • BEUGEL	FIS-C Ø	15,65	16,94	16,94	18,14	18,95	18,95	19,40	19,82	20,17	20,17	21,91	24,67	25,91	36,54
GRIFFE • GRIKPELING	FIS-G Ø	-	-	-	-	-	29,48	29,95	30,16	-->	32,71	35,15	36,92	43,27	-
RACCORD FLEXIBLE - RIGIDE • MOF VAST. - FLEX	FIS-RFR Ø	-	-	17,23	18,17	-	18,34	19,02	19,02	19,74	19,74	20,40	20,40	21,48	-
RACCORD GAINÉ • VERLOOPSTUK	FIS-R Ø	16,56	16,56	16,56	16,56	16,56	17,37	17,79	17,79	18,60	18,60	19,49	19,49	20,27	45,14
OGIVE BOIS • HOUT KOGEL	FIS-OS-Ø	60,62	-	72,02	75,84	75,84	83,40	85,05	87,16	90,94	90,94	103,43	113,77	121,31	137,19
PLAQUE LIAISON RIGIDE - FLEX ANKERPLAAT FLEX - VAST.	FIS-PL Ø	-	-	53,30	-	-	54,59	54,59	55,97	55,97	57,25	58,01	58,50	59,83	64,97
CHAPEAU PAREPLUIE • REGENKAP	I-CHO-Ø	36,55	-	36,55	36,55	-	36,55	36,55	36,55	44,72	-	-	44,72	44,72	69,63

* Ø 139, 154, 167, 180, 200, 250 POUR T316 TUBAGE 135° + PURGE SUR COMMANDE UNIQUEMENT • VOOR T316 BUIS 135° + CONDENSVOER EWKEL OP BESTELLING



FIS - T6 - Ø FIS - T4 - Ø FIS - TY6 - Ø FIS - PO - Ø FIS - C Ø FIS - G Ø FIS - RFR Ø FIS - R Ø FIS - OS - Ø FIS - PL Ø I - CHO - Ø

CHAPEAUX • VARINOX • REGENKAP			
DESCRIPTION • BESCHRIJVING	Ø	REF	€
ASPIRATEUR STATIQUE TREKKAP	80-116	VAR 1	94,48
	125-161	VAR 2	110,76
	167-206	VAR 3	129,41

CHAPEAUX CHINOIS • CHINESE REGENKAP			
DESCRIPTION • BESCHRIJVING	Ø	REF	€
CHAPEAU CHINOIS INOX REGENKAP INOX	80-111	I - CHU - 1	43,78
	120-140	I - CHU - 2	48,05
	153-180	I - CHU - 3	60,93
	200-250	I - CHU - 4	69,02
	300	I - CHU - 5	100,50

CHAPEAUX DYNAMIQUE • TURBO • DRAAIENDE TREKKENDEKAP			
DESCRIPTION • BESCHRIJVING	Ø	REF	€
OUVRANT OPENEND	80-120	TURBO 80B	147,00
	130-160	TURBO 130B	159,00
	160-200	TURBO 160B	168,00
	200-240	TURBO 200B	177,00
NON-OUVRANT NIET OPENEND	80-120	TURBO 80-130	132,17
	130-160	TURBO 130 - 160	139,59
	160-200	TURBO 160 - 200	147,02
	200-240	TURBO 200 - 240	154,44

MODERATEURS DE TIRAGE • TREKREGELAAR MODERATORS		
Ø	REF	€
97 - 130	MOD 1	53,30
140 - 200	MOD 2	72,22
225 - 250	MOD 3	156,84



KIT HAUBANAGE • TUIDDRAAD KIT		
DESCRIPTION • BESCHRIJVING	REF	€
CABLE HAUBANAGE INOX DIAM. 3MM INOX TUIDDRAARD KABEL 3MM	I - HC	3,44
SERRE CABLE INOX 3MM BROEIKAS KABEL 3MM	I - HS	2,50
TENDEUR INOX 3MM INOX SPANNER 3MM	I - HT	12,53

RACCORD JONCTION FLEXIBLE • KOPPELSTUK TUSSEN 2 FLEXIBEL								
Ø INT • BINNEN Ø		111	125	140	153	167	180	200
RACCORD KOPPELSTUKKEN	REF	FIS-RP111D	FIS-RP126D	FIS-RP141D	FIS-RP156D	FIS-RP167D	FIS-RP180D	FIS-RP200D
	€	88,67	71,30	88,67	71,30	73,90	71,30	71,30
DIMENSIONS / AFMETINGEN		153 / 125	180 / 153	180 / 167	200 / 180	200 / 167	200 / 153	-
RÉDUCTION RÉDUCTIE	REF	FIS-RP12156D	FIS-RP18156D	FIS-RP18167D	FIS-RP20180D	FIS-RP20167D	FIS-RD20156D	-
	€	88,67	80,12	80,12	86,35	86,35	86,35	-

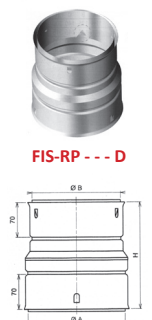

FIS-RP - - - D

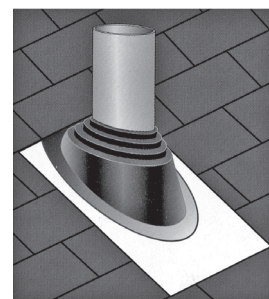
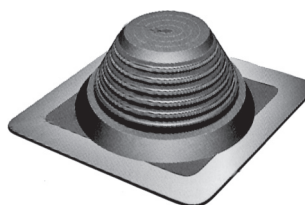
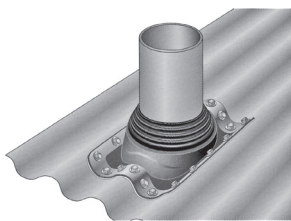
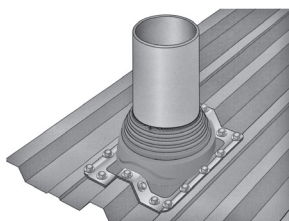

BAVETTE ALU MALLÉABLE
BUIGZAAN ALU BASISPLAAT

EPAL

MONTAGE :

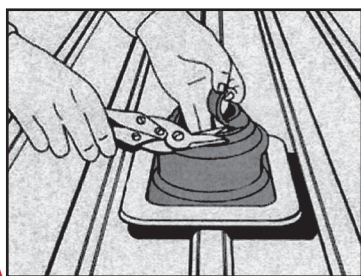

A. COUPER LE MANCHON SELON LE Ø DE CONDUIT À ÉTANCHER.
A. KNIP CONUS AF OP DE AANGEGEVEN PIJPDIAMETER

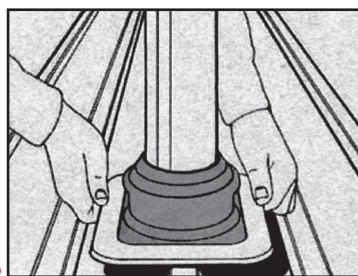

B. ENGAGER LE MANCHON SUR LE CONDUIT ET LE FAIRE GLISSER JUSQU'AU PROFIL.
B. SCHUIF DOORVOER OVER DE PIJP

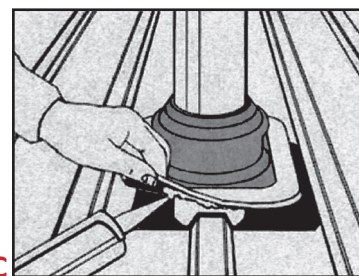

C. APPLIQUER LE MASTIC (FOURNI DANS LE KIT) SOUS L'EMBASE DU MANCHON.
C. BRENG AAN ONDERZIJDE BEVESTIGINGSRAND EEN NEUTRALE SILICONENKIT AAN

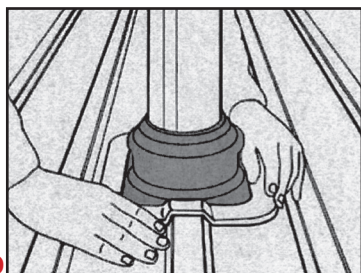

D. ADAPTER L'EMBASE À LA FORME EXACTE DU PROFIL EN MODELANT L'INSERT ALU.
D. BUIG BEVESTIGINGSRAND IN VORM DAKPROFIEL

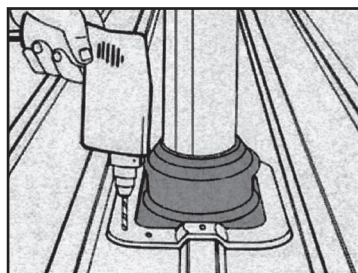

E. FIXER LE MANCHON EN UTILISANT LES VIS FOURNIES DANS LE KIT
E. BEVESTIG DOORVOER MET ZELFBORENDE OF ZELFTAPPENDE SCHROEVEN

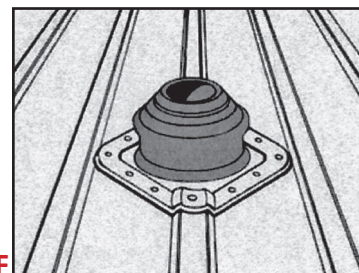

F. MANCHON À 45° POUR DIAM. IMPORTANT, TOITURE À FORTE PENTE ET PROFIL GRANDE PORTÉE
F. PLAATS DOORVOER DIAGONAAL BIJ GROTE GATEN EN IN GEVAL VAN HOGE PROFILERING

KIT	DIMENSIONS DE L'EMBASE BASISAFMETINGEN	DIAM. TUYAU MIN - MAX BUISDIAM. MIN EN MAX	REF	€
KIT 1	218 * 218 MM	32 - 82	EPDM 2	25,00
KIT 1	284 * 284 MM	76 - 152	EPDM 4	42,00
2X KIT 1	365 * 365 MM	127 - 228	EPDM 6	69,36
2X KIT 1	453 * 453 MM	178 - 330	EPDM 8	99,00
EPDM • 100°C EN CONTINU - 150°C MAX. • WERKING 100°C - 150°C MAX.				
2X KIT 1	365 * 365 MM	127 - 228	EPD-SIL 6	126,16
2X KIT 1	453 * 453 MM	178 - 330	EPD-SIL 8	205,20
SILICONE • 200°C EN CONTINU - 250°C MAX. • WERKING 200°C - 250°C MAX.				
-	508 * 508 MM	76 - 203	EPAL-76-203	50,90
-	660 * 660 MM	203 - 280	EPAL-203-280	77,12
DESCRIPTION • BESCHRIJVING			REF	€
SILICONE, VIS AVEC JOINT ÉTANCHE ET CAPUCHON COULEUR RAL9006 SILICONE, SCHROEVEN MET AFDICHTINGRING EN VAST KLEUR KAP RAL9006			EP - KIT 1	30,86
KIT DE FIXATION SUR PLAQUE FIBRO-CIMENT • KIT OP FIBRO-CEMENTPLAAT			EP - KIT 1 FIBRO	53,46



EP - KIT 1



EP - KIT 1 FIBRO

En été, les toitures métalliques peuvent dépasser les 50°C. La plupart des silicones peuvent se fissurer au dessus de 50°C. C'est pour cela que nous vous conseillons l'utilisation des kits fournis avec nos produits.

Stalen daken worden warm in de zon. De meeste siliconekitten worden boven de 50°C broos, met als gevolg een lekkage. Wij adviseren U daarom, ook onze Montagekit te gebruiken met onze produkten.

ØINT/BIN		60	80
ALUMINIUM BLANC - WIT ALUMINIUM			
TUBE 2000 MM BUIS 2000 MM	REF	ALB60*2M	ALB80*2M
	€	23,28	24,00
TUBE 1000 MM BUIS 1000 MM	REF	ALB60*1M	ALB80*1M
	€	13,65	14,95
TUBE 500 MM BUIS 500 MM	REF	ALB60*50CM	ALB80*50CM
	€	9,52	9,80
COUDE 90° M-F BOCHT 90° M-VR	REF	ALBC90MF60	ALBC90MF80
	€	12,00	10,00
COUDE 90° F-F BOCHT 90° VR-VR	REF	ALBC90FF60	ALBC90FF80
	€	14,10	13,50
COUDE 45° M-F BOCHT 45° M-VR	REF	ALBC45MF60	ALBC45MF80
	€	9,41	9,50
COUDE 45° F-F BOCHT 45° VR-VR	REF	ALBC45FF60	ALBC45FF80
	€	-	13,36
TÉ 90° T-STUK 90°	REF	ALBT60	ALBT80
	€	24,00	25,00
COLLIER MURAL MUURBEUGEL	REF	ALBCM60	ALBCM80
	€	4,42	4,83
ROSACE SILICONE SILICON SCHOUWPLAAT	REF	RCB60	RCB80
	€	4,00	6,00
ROSACE ALU ALU SCHOUWPLAAT	REF	ALBRR60	ALBRR80
	€		8,15
MANCHON FEMELLE-FEMELLE MOF VROUW-VROUW	REF	ALBMFF60	ALBMFF80
	€	8,00	8,00
GRILLE RONDE KEMP KEMP ROND ROOSTER	REF	KBFP0B	KBFPOR80B
	€	8,90	14,90



ØINT/BIN		60	80
ALU NOIR - ZWART ALU			
TUBE 2000 MM BUIS 2000 MM	REF	ALN60*2M	ALN80*2M
	€	25,45	26,00
TUBE 1000 MM BUIS 1000 MM	REF	ALN60*1M	ALN80*1M
	€	15,05	15,96
TUBE 500 MM BUIS 500 MM	REF	ALN60*50CM	ALN80*50CM
	€	10,02	10,24
COUDE 90° M-F BOCHT 90° M-VR	REF	ALNC90MF60	ALNC90MF80
	€	13,70	12,00
COUDE 90° F-F BOCHT 90° VR-VR	REF	ALNC90FF60	ALNC90FF80
	€	14,70	14,50
COUDE 45° M-F BOCHT 45° M-VR	REF	ALNC45MF60	ALNC45MF80
	€	10,00	11,50
COUDE 45° F-F BOCHT 45° VR-VR	REF	ALNC45FF60	ALNC45FF80
	€	-	14,86
TÉ 90° T-STUK 90°	REF	ALNT60	ALNT80
	€	24,00	27,00
COLLIER MURAL MUURBEUGEL	REF	ALNCM60	ALNCM80
	€	7,16	7,44
ROSACE SILICONE SILICON SCHOUWPLAAT	REF	RCN60	RCN80
	€	6,00	6,00
ROSACE ALU ALU SCHOUWPLAAT	REF	ANR-60	ANR-80
	€		11,00
MANCHON FEMELLE-FEMELLE MOF VROUW-VROUW	REF	ALNMFF60	ALNMFF80
	€	8,70	8,70
GRILLE RONDE KEMP KEMP ROND ROOSTER	REF	KBFPON	KBFPOR80N
	€	9,50	15,90



ØINT/BIN		80	90	100	110	120	125	130	140	150	160	180	200	250
FLEXIBLE ALUMINIUM - ALUMINIUM FLEXIBEL														
3M	REF	FLAL 80	FLAL 90	FLAL 100	FLAL 110	FLAL 120	FLAL 125	FLAL 130	FLAL 140	FLAL 150	FLAL 160	FLAL 180	FLAL 200	FLAL 250
	€	9,50	10,60	11,70	12,95	14,03	14,89	15,30	16,75	18,63	19,12	21,42	24,00	30,23
1,5M Ø60	REF	FLAL.060												
	€	15,72												
MANCHON GALVA M-M GALVA MOF M-M	REF	FLALM 80	FLALM 90	FLALM 100	FLALM 110	FLALM 120	FLALM 125	FLALM 130	FLALM 140	FLALM 150	FLALM 160	FLALM 180	FLALM 200	FLALM 250
	€	7,60	7,60	7,60		7,60	7,60	7,60	7,60	7,60	13,21	13,21	17,66	20,75

ACCESSOIRES • TOEBEHOREN			
DESCRIPTION • BESCHRIJVING		REF	€
BANDE ALU 50M		BAL	16,07
BANDE ALU 5M		BAL4	2,26

ØINT/BIN		80	100	125	150
GAINES ALU SOUPLE -					
10M ISOLÉ 10M ISOLEERD	REF	FL.AL80.IS	FL.AL100.IS	FL.AL125.IS	FL.AL150.IS
	€	79,66	97,27	107,68	*
10M NON ISOLÉ 10M GEEN ISOLLERD	REF	FL.AL80.SP	FL.AL100.SP	FL.AL125.SP	FL.AL150.SP
	€	30,85	*	*	*

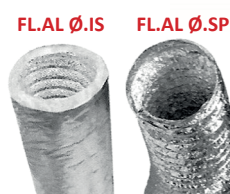

- CONDUIT SIMPLE PAROI À SECTION OVALE INOX 304 ^{5/10} - DISPONIBLE AUSSI EN INOX 316 ^{5/10} SUR COMMANDE
- ENKELWANDIG OVAAL BUIS INOX 304 ^{5/10} - INOX 316 ^{5/10} OP BESTELLING

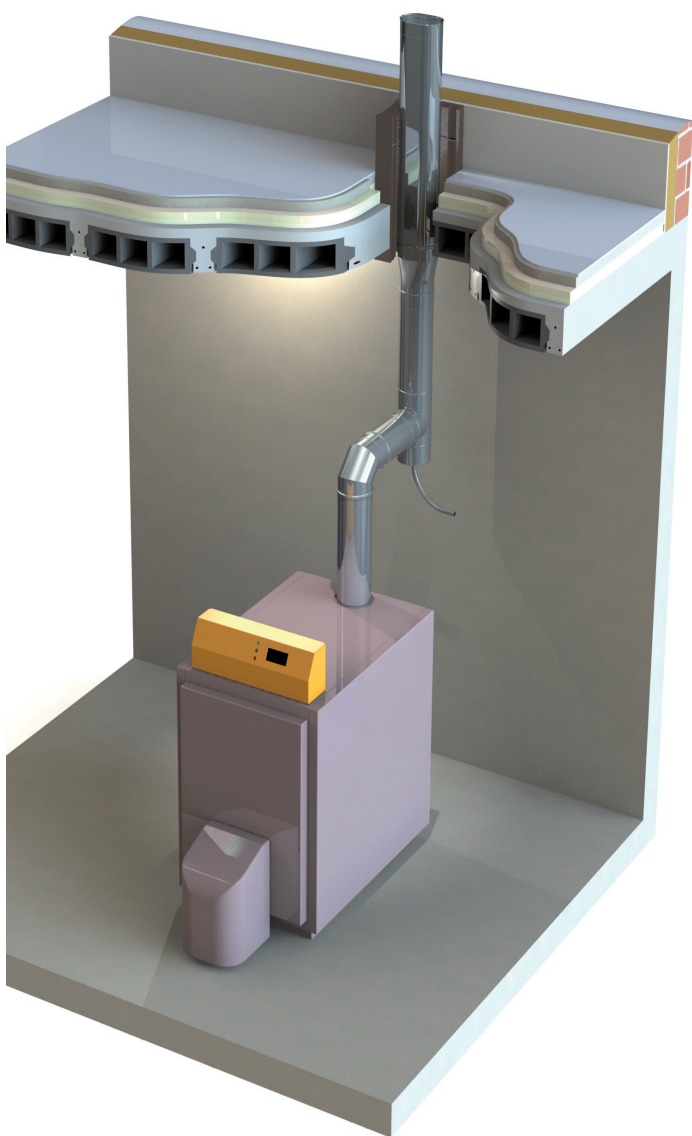

• Application principale - hoofdtoepassing :

- Tubage de boisseaux rectangulaires
- Générateurs et foyers traditionnels (hors basse T° et condensation)
- Tubage van vierhoekige rookkanallen
- Standard en traditionele brandens behalve lage T° en condensatie

• Installation dans - plaatsing :

- Batiments individuels | - Prive woningen
- Petit collectif | - Kleine appartementen gebouwen

• Combustible - brandstof :

- Bois | - Hout
- Fioul | - Olie
- Gaz | - Gas

Composition configuration - samenstelling :

- | | |
|--------------------------|----------------------------|
| 1. Element droit ovalisé | 1. Ovaal rechte buis |
| 2. Adaptateur oval-rond | 2. Overgangstuk ovaal-rond |
| 3. Purge | 3. Condensafvoer |
| 4. Coude 90° | 4. Bocht 90° |

+ PRODUITS - + PRODUCT :

- Permet le maintien d'une section optimal lors du tubage boisseau rectangulaire
- Adapté aux boisseaux rectangulaires standards
- Om en bepaalde diameter te behouden in een vierhoekige rookkanaal
- Aangepast voor standard rookkanallen

BON A SAVOIR - TIPS :

- Collier de jonction obligatoire en tubage
- Raccordement à la gamme **SP inox** avec l'adaptateur oval-rond
- Klemband verplicht voor tubage
- Aangepast met onze **EW gamma** met mof ovaal-rond

OBLONG EN MM - OVAAL MM	110*150	125*180	160*200	480*240	180*290	175*325
Ø ÉQUIVALENT	130	153	180	200	230	250
CARACTÉRISTIQUES TECHNIQUES - OVAAL - TECHNISCHE KENMERKEN						
PAROI - WAND	INOX 304 ^{5/10}					
EMBOITEMENT - INEENSCHUIVING	60 MM					
COLLIER DE JONCTION - KLEMBAND	NON FOURNI - NIET GELEVERD					
CLASSIFICATION - CLASSIFICATIE	T450 N1 D VmL 20050G (tubage)					

DISPONIBLE EN INOX 316L +15% AVEC LE CODE **ISOV6** AU LIEU DE **ISOV4**
 BESCHIKBAAR IN 316L INOX + 15% MET **ISOV6**-CODE IN PLAATS VAN **ISOV4**

**TUBAGE OVAL
 OVAAL INOX**

		INOX OVALISÉ ^{5/10} - OVAAL INOX ^{5/10}						
LONG UTILE NUTTIGE LENGTE	LONG TOTAL TOTALE LENGTE	SECTION	110*150	125*180	160*200	180*240	180*290	175*325
		ØINT/BIN	130	153	180	200	230	250
ÉLÉMENTS DROITS - RECHTE BUIS								
1000 MM	940 MM	REF	ISOV4 1301000	ISOV4 1531000	ISOV4 1801000	ISOV4 2001000	ISOV4 2301000	ISOV4 2501000
		€	65,97	70,83	79,39	87,19	99,93	109,59
500 MM	440 MM	REF	ISOV4 130500	ISOV4 153500	ISOV4 180500	ISOV4 200500	ISOV4 230500	ISOV4 250500
		€	36,14	38,78	43,96	48,09	54,77	60,02
330 MM	270 MM	REF	ISOV4 130330	ISOV4 153330	ISOV4 180330	ISOV4 200330	ISOV4 230330	ISOV4 250330
		€	23,47	24,98	28,33	31,28	35,37	38,78



TÉ - T-STUK							
T 90° PIQUAGE PETIT COTÉ T 90° + MOF KLEINE KANT	REF	ISOV4TPC 130	ISOV4TPC 153	ISOV4TPC 180	ISOV4TPC 200	ISOV4TPC 230	ISOV4TPC 250
	€	55,75	59,61	63,20	74,53	87,18	95,27
T 90° PIQUAGE GRAND COTÉ T 90° + MOF GROOTE KANT	REF	ISOV4TGC 130	ISOV4TGC 153	ISOV4TGC 180	ISOV4TGC 200	ISOV4TGC 230	ISOV4TGC 250
	€	55,75	59,61	63,20	74,53	87,18	95,27
T RAMONAGE PETIT COTÉ T + KIJKDEUR KLEINE KANT	REF	ISOV4TRPC 130	ISOV4TRPC 153	ISOV4TRPC 180	ISOV4TRPC 200	ISOV4TRPC 230	ISOV4TRPC 250
	€	91,59	98,07	107,40	117,81	192,14	234,90
T RAMONAGE GRAND COTÉ T + KIJKDEUR GROOTE KANT	REF	ISOV4TRGC 130	ISOV4TRGC 153	ISOV4TRGC 180	ISOV4TRGC 200	ISOV4TRGC 230	ISOV4TRGC 250
	€	91,59	98,07	107,40	117,81	192,14	234,90



COLLIER DE JONCTION - KLEMBAND							
REF	ISOV4BS 130	ISOV4BS 153	ISOV4BS 180	ISOV4BS 200	ISOV4BS 230	ISOV4BS 250	
€	18,51	18,51	18,51	18,51	18,51	18,51	



CHAPEAU - KAP							
REF	ISOV4CH 130	ISOV4CH 153	ISOV4CH 180	ISOV4CH 200	ISOV4CH 230	ISOV4CH 250	
€	63,31	63,31	69,97	76,99	88,31	98,31	

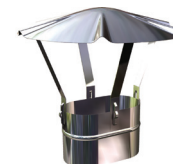

LARMIER - STORMKRAAG							
REF	ISOV4LA 130	ISOV4LA 153	ISOV4LA 180	ISOV4LA 200	ISOV4LA 230	ISOV4LA 250	
€	49,75	52,06	54,37	56,68	59,00	62,48	



PLAQUE D'ÉTANCHÉITÉ - AFWERKINGSPLAAT							
REF	ISOV4PO 130	ISOV4PO 153	ISOV4PO 180	ISOV4PO 200	ISOV4PO 230	ISOV4PO 250	
€	48,00	48,00	48,00	48,00	48,00	48,00	

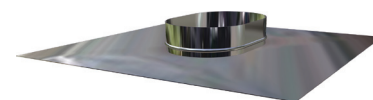

COLLIER DE FIXATION HAUTE - BEVESTIGINGSBEUGEL							
REF	ISOV4CO 130	ISOV4CO 153	ISOV4CO 180	ISOV4CO 200	ISOV4CO 230	ISOV4CO 250	
€	44,72	44,72	44,72	44,72	44,72	44,72	

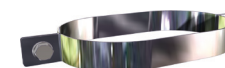

ADAPTATEUR OVAL-ROND - MOF OVAAL-ROND							
REF	ISOV4OVRD 130	ISOV4OVRD 153	ISOV4OVRD 180	ISOV4OVRD 200	ISOV4OVRD 230	ISOV4OVRD 250	
€	87,94	90,25	94,88	99,52	105,30	116,87	



SUPPORT MURAL RAPIDE (ROND) - MUURSTEUN (ROND)							
REF	ISSM130	ISSM153	ISSM180	ISSM200	ISSM230	ISSM250	
€	85,82	88,19	95,36	101,85	113,55	132,18	

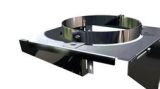

J.P. VOS



HI THERM PRODUCTS

S.P.R.L.

2018



MODINOX
CONDUITS DE CHEMINÉE

VOTRE REVENDEUR



UW DEALER

**TARIF INDICATIF • FRANCO À PARTIR DE 250€
CONDITIONS GENERALES DE VENTES SUR WWW.JPVOS.BE**

**INDICATIEF TARIEF • FRANKO VANAF 250€
ALGEMENE VERKOOPSVOORWAARDEN OP WWW.JPVOS.BE**

